

SHEET 1 OF 20 SHEETS

**STRATA PLAN OF LOT 2 BLOCK 14 DISTRICT
LOT 185 GROUP 1 N.W.D. PLAN BCP4100**

B.C.G.S. 92G.025
CITY OF VANCOUVER
INTEGRATED SURVEY AREA No. 31 CITY OF VANCOUVER

THIS PLAN SHOWS GROUND LEVEL MEASURED DISTANCES.
PRIOR TO COMPUTATION OF U.T.M. COORDINATES MULTIPLY
BY COMBINED FACTOR OF 0.9996027

GRID BEARINGS ARE (NAD83 CSRS) DERIVED FROM
CONTROL MONUMENTS V-2789 AND V-3148

LEGEND

- DENOTES CONTROL MONUMENT FOUND
- DENOTES STANDARD IRON POST FOUND
- ◆ DENOTES STANDARD LEAD PLUG FOUND
- SL DENOTES STRATA LOT
- ⊙ DENOTES COMMON PROPERTY
- m² DENOTES SQUARE METRES
- A DENOTES AREA
- ⓑ DENOTES BALCONY
- Ⓣ DENOTES TERRACE

LCP33 DENOTES LIMITED COMMON PROPERTY
(TYPICAL) FOR EXCLUSIVE USE OF STRATA LOT 33
ALL BEARINGS ARE CARDINAL OR 45°
UNLESS OTHERWISE NOTED

STRATA LOT BOUNDARIES ARE DEFINED BY
OUTSIDE OF EXTERNAL WALLS, CORRIDOR SIDE
OF CORRIDOR AND COREWALLS AND CENTRELINE
OF WALL BETWEEN STRATA LOTS.

THE 13th FLOOR HAS BEEN OMITTED.

STRATA PLAN BCS 856

DEPOSITED AND REGISTERED IN THE LAND TITLE
OFFICE AT NEW WESTMINSTER, B.C.
THIS 21st DAY OF June, 2004

D. Whittell /os.
DEPUTY REGISTRAR

BW 272871 - DW272976

SCALE 1 : 500



ALL DISTANCES ARE IN METRES

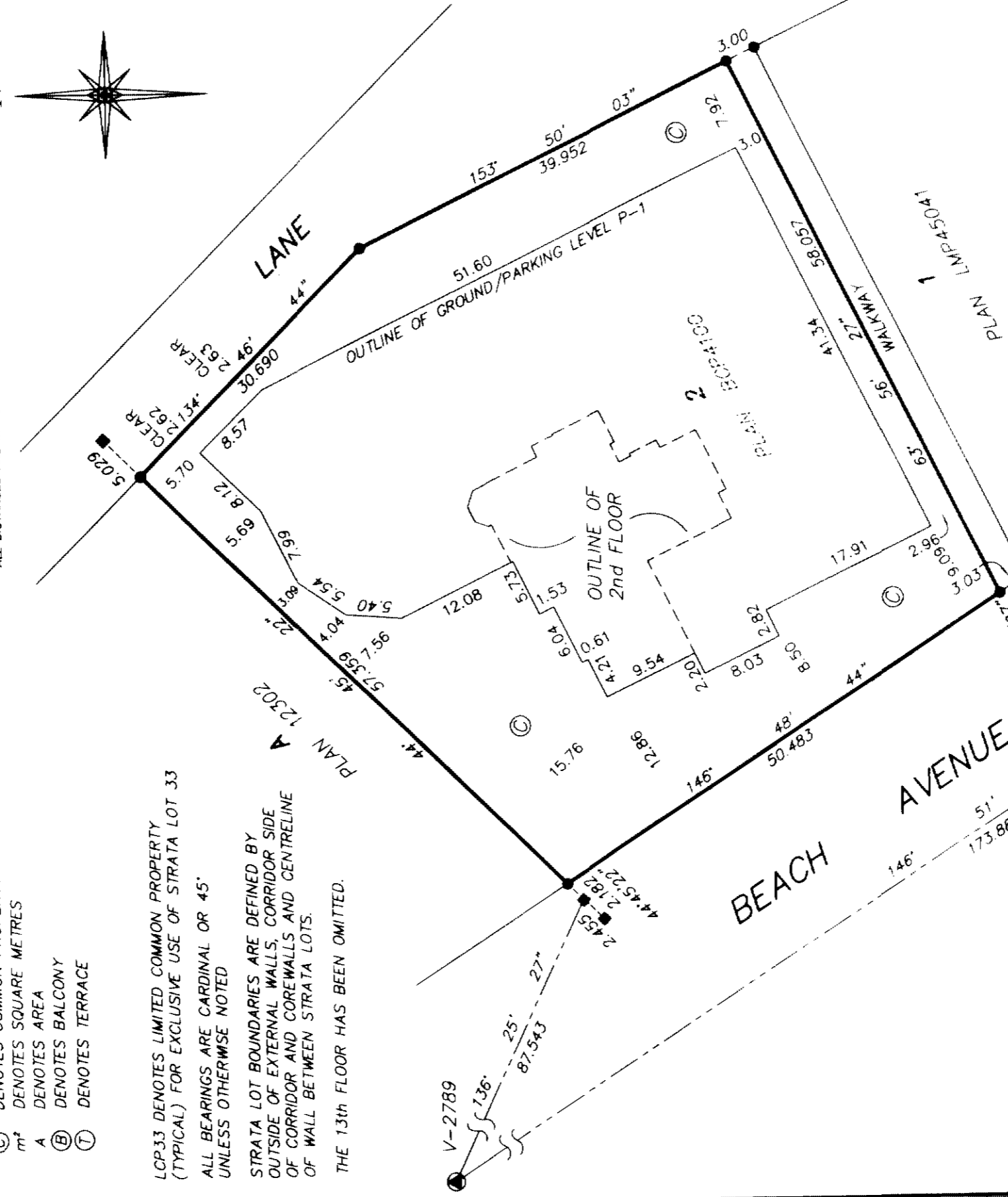
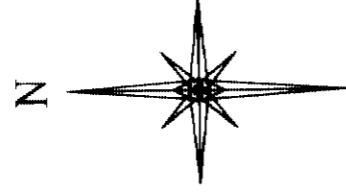

I, DIETER SOUKUP OF SURREY, A BRITISH
COLUMBIA LAND SURVEYOR, CERTIFY THAT
THE BUILDING INCLUDED IN THIS STRATA
PLAN HAS NOT, AS OF THE 13th DAY OF
MAY, 2004 BEEN PREVIOUSLY OCCUPIED.
DATED THIS 13th DAY OF MAY, 2004.

Dieter Soukup B.C.L.S.

I, DIETER SOUKUP, OF SURREY, A BRITISH
COLUMBIA LAND SURVEYOR, CERTIFY THAT
THE BUILDING SHOWN ON THIS STRATA PLAN
IS WITHIN THE EXTERNAL BOUNDARIES OF
THE LAND THAT IS THE SUBJECT OF THE
STRATA PLAN.

DATED THIS 13th DAY OF MAY, 2004.

Dieter Soukup B.C.L.S.

I, DIETER SOUKUP, A BRITISH COLUMBIA LAND SURVEYOR
OF SURREY, IN BRITISH COLUMBIA, CERTIFY THAT I WAS
PRESENT AT AND PERSONALLY SUPERINTENDED THE SURVEY
REPRESENTED BY THIS PLAN, AND THAT THE SURVEY AND
PLAN ARE CORRECT. THE FIELD SURVEY WAS COMPLETED ON
THE 13th DAY OF MAY, 2004. THE PLAN WAS COMPLETED
AND CHECKED, AND CHECKLIST FILED UNDER #15240, ON THE
13th DAY OF MAY, 2004

Dieter Soukup B.C.L.S.

SOUKUP LAND SURVEYING INC.
#201 - 8484 - 162 STREET,
SURREY, B.C., VAN 1B4
TEL: 597-6161 FAX: 597-0259
FILE: 5267-P1 (ALVAR)
DISK: CD-1

CIVIC ADDRESS OF PROPERTY
1005 - BEACH AVENUE
VANCOUVER, B.C.

V-3148

THIS PLAN LIES WITHIN THE GREATER VANCOUVER DISTRICT

SHEET 2 OF 20 SHEETS

STRATA PROPERTY ACT

STRATA PLAN BCS 856

OWNER:
CONCERT REAL ESTATE CORPORATION,
(INC. NO. C424436)
BY ITS AUTHORIZED SIGNATORIES

NAME: DAVID R. PODMORE

RESIDENT AND
Chief Executive Officer

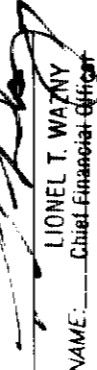
NAME: LIONEL T. WAZNY
Chief Financial Officer

WITNESS:
AS TO BOTH SIGNATURES

NAME: J.S. MacDonald
2237 W. 13th Ave.

ADDRESS OF WITNESS
Marketing Coordinator
OCCUPATION OF WITNESS

MORTGAGEE:
THE BANK OF NOVA SCOTIA
BY ITS AUTHORIZED SIGNATORIES

NAME: John Matthews

NAME: _____

WITNESS:
AS TO BOTH SIGNATURES

NAME: Angela Shum
1800 - 650 W. Georgia St.

ADDRESS OF WITNESS
Secretary
OCCUPATION OF WITNESS

DATED THIS 13th DAY OF
MAY, 2004.

 B.C.L.S.

FILE: 5267-P1 DISK: CD-1

SHEET 3 OF 20 SHEETS

PARKING LEVEL P-3

STRATA PLAN BCS-856

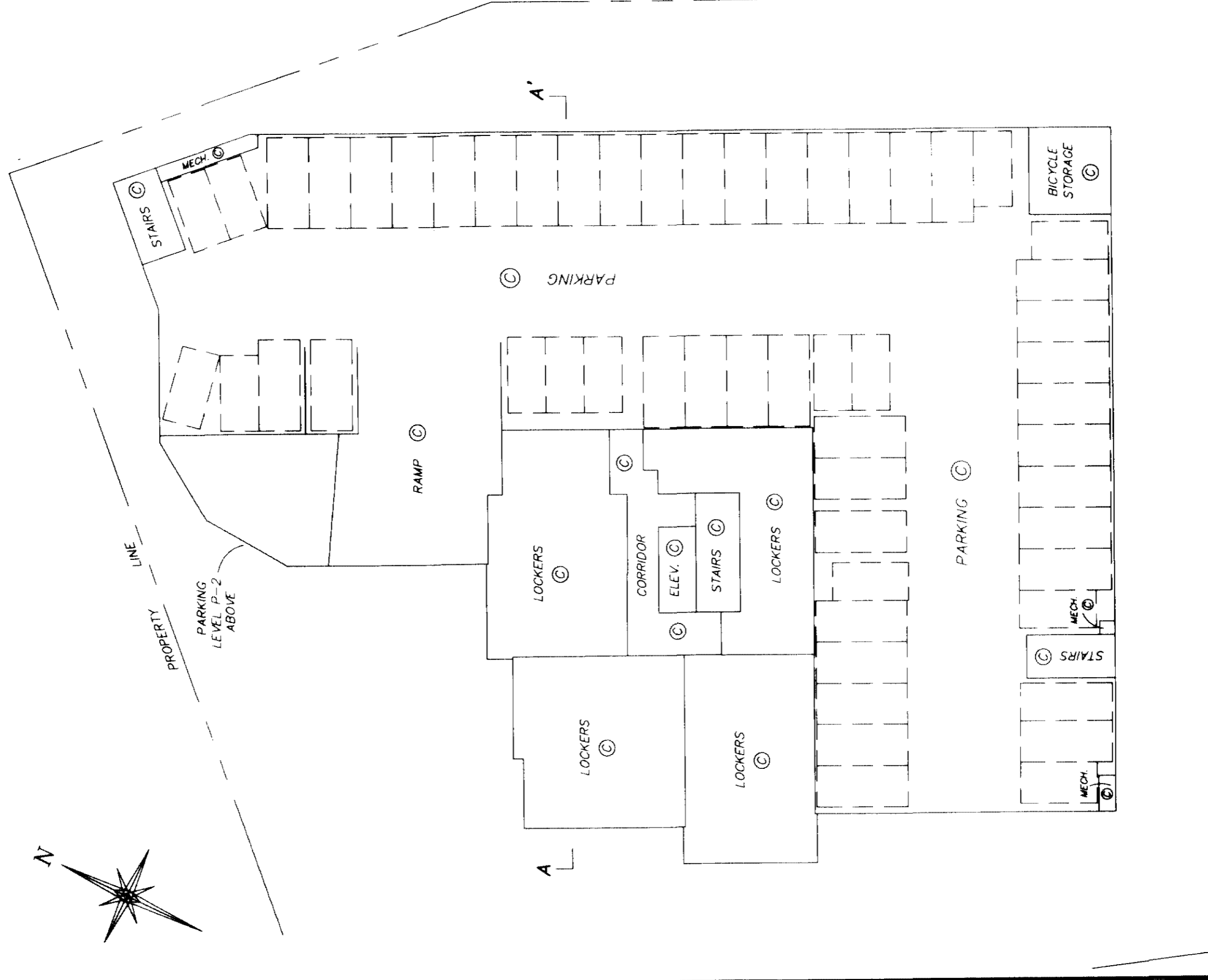
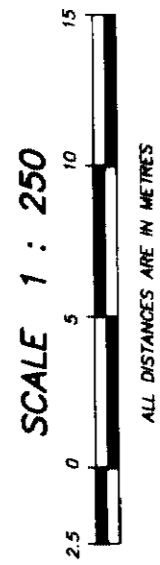

DATED THIS 13th DAY OF MAY, 2004.

FILE: 5267-P2 DISK: CD-1

SHEET 4 OF 20 SHEETS

STRATA PLAN BCS 856

PARKING LEVEL P-2

SCALE 1 : 250

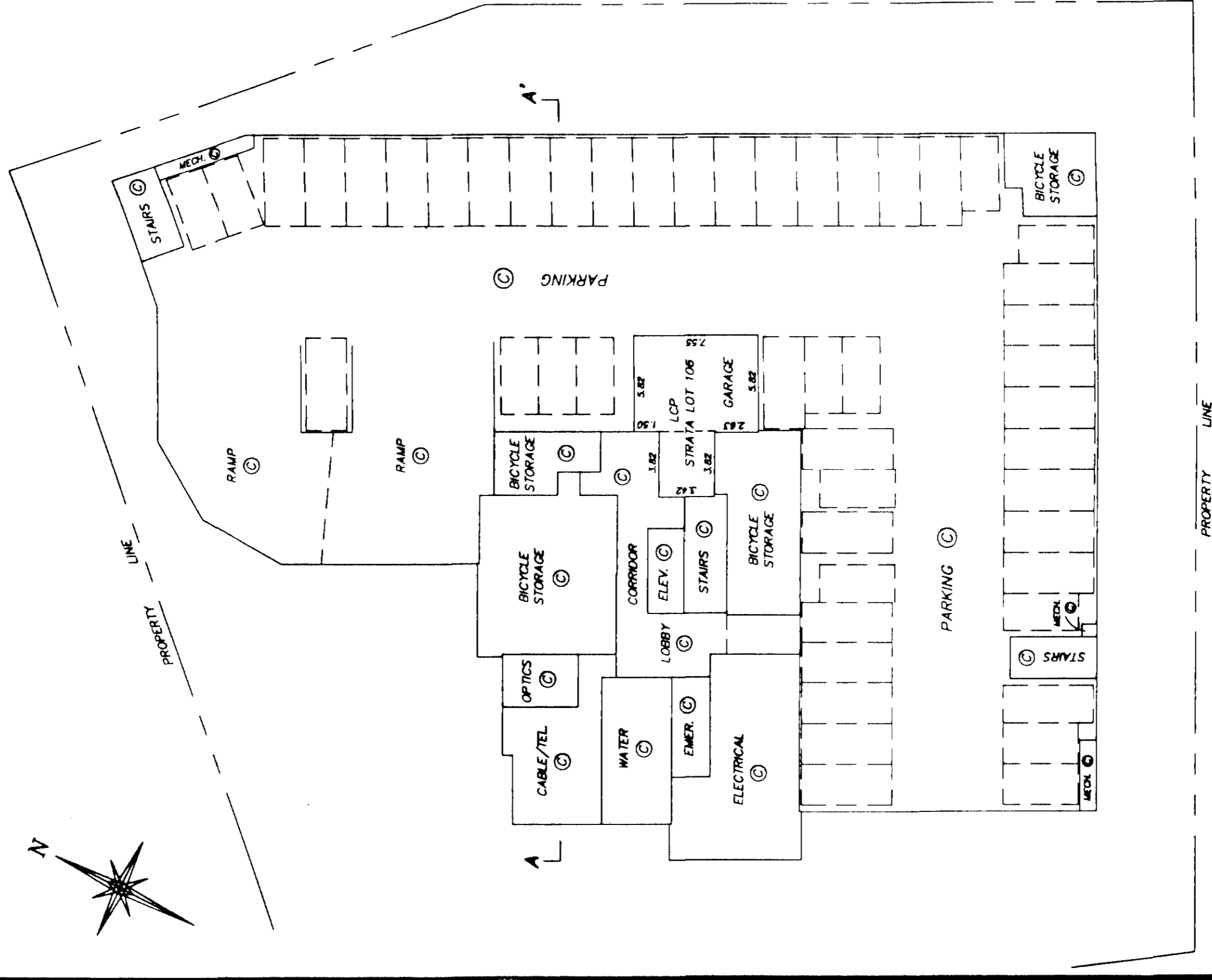

DATED THIS 13th DAY OF MAY, 2004.

[Signature]
 B.C.L.S.
 FILE: 5267-P2 DISK: CD-1

SHEET 5 OF 20 SHEETS

GROUND FLOOR/PARKING LEVEL P-1

STRATA PLAN BCS_856

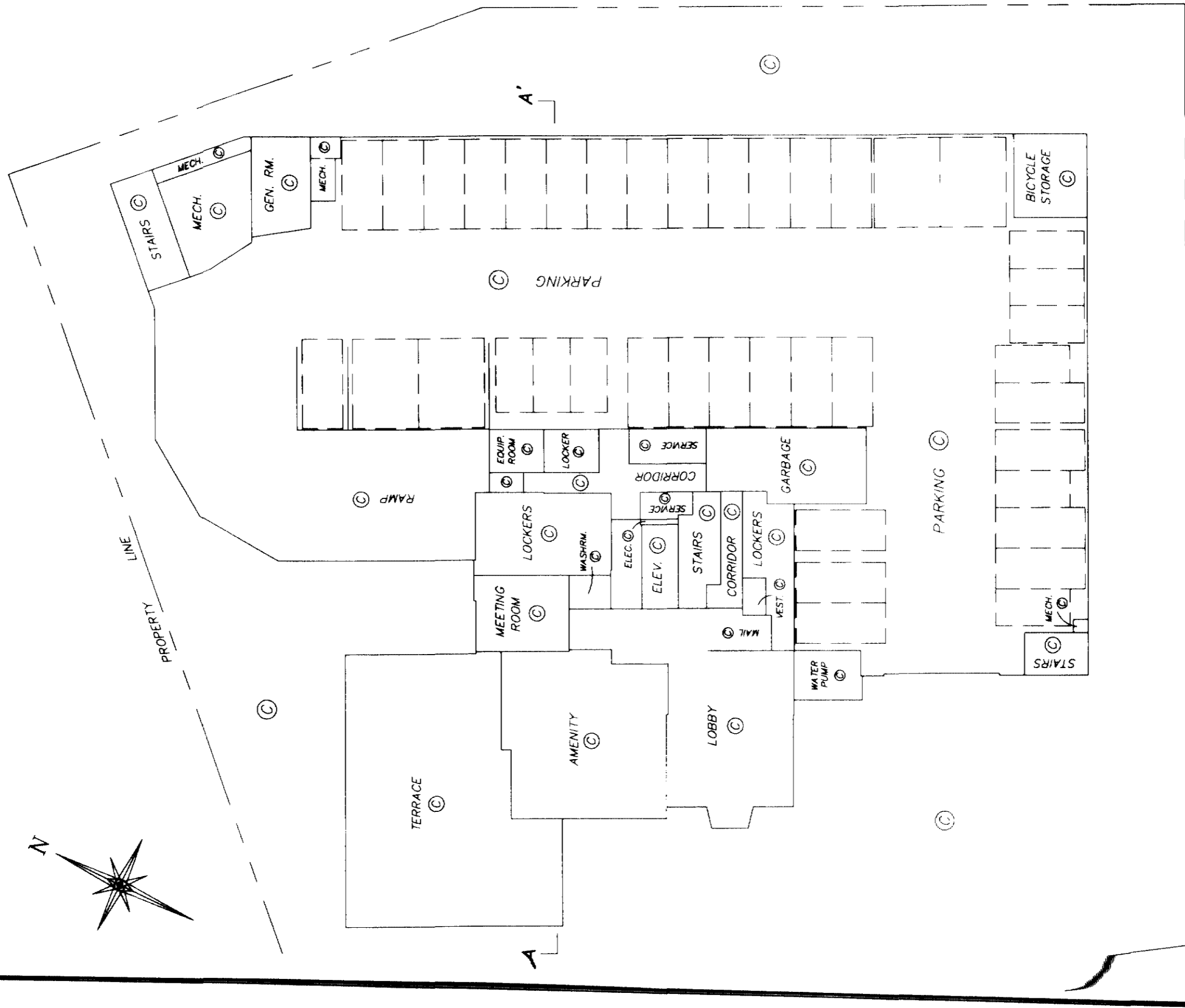
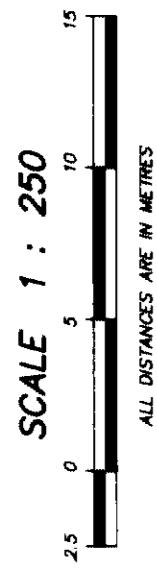

DATED THIS 13th DAY OF
MAY, 2004.

[Signature]
B.C.L.S.

FILE: 5267-P2 DISK: CD-1

SHEET 6 OF 20 SHEETS

STRATA PLAN BCS 856

FLOOR PLANS

SCALE 1 : 250



ALL DISTANCES ARE IN METRES



PERIMETER OF LEVEL BELOW

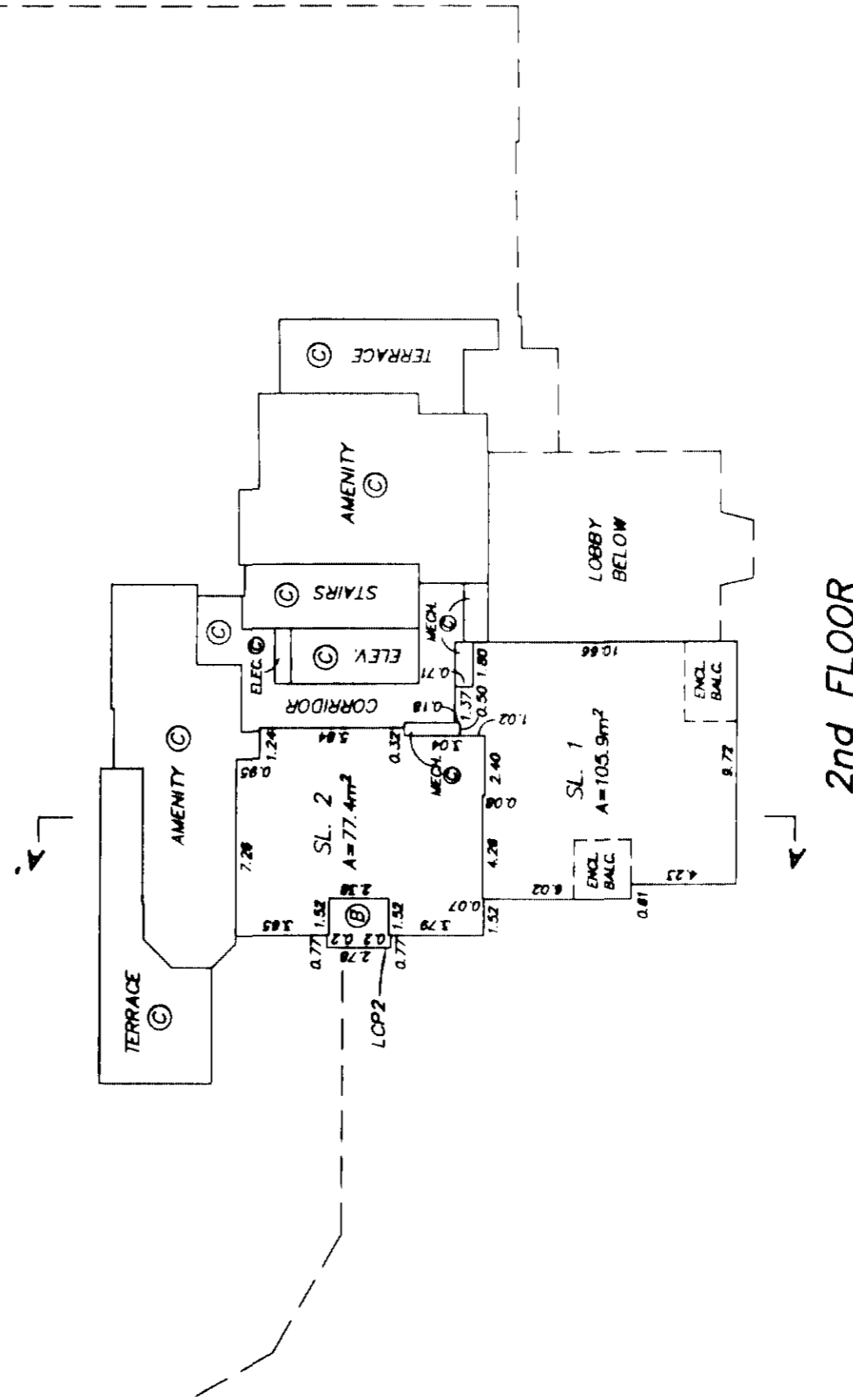

DATED THIS 13th DAY OF MAY, 2004.

B.C.L.S.

 FILE 5267-P2 DISK: CD-1

SHEET 7 OF 20 SHEETS

STRATA PLAN BCS 856

FLOOR PLANS

SCALE 1 : 250



ALL DISTANCES ARE IN METRES

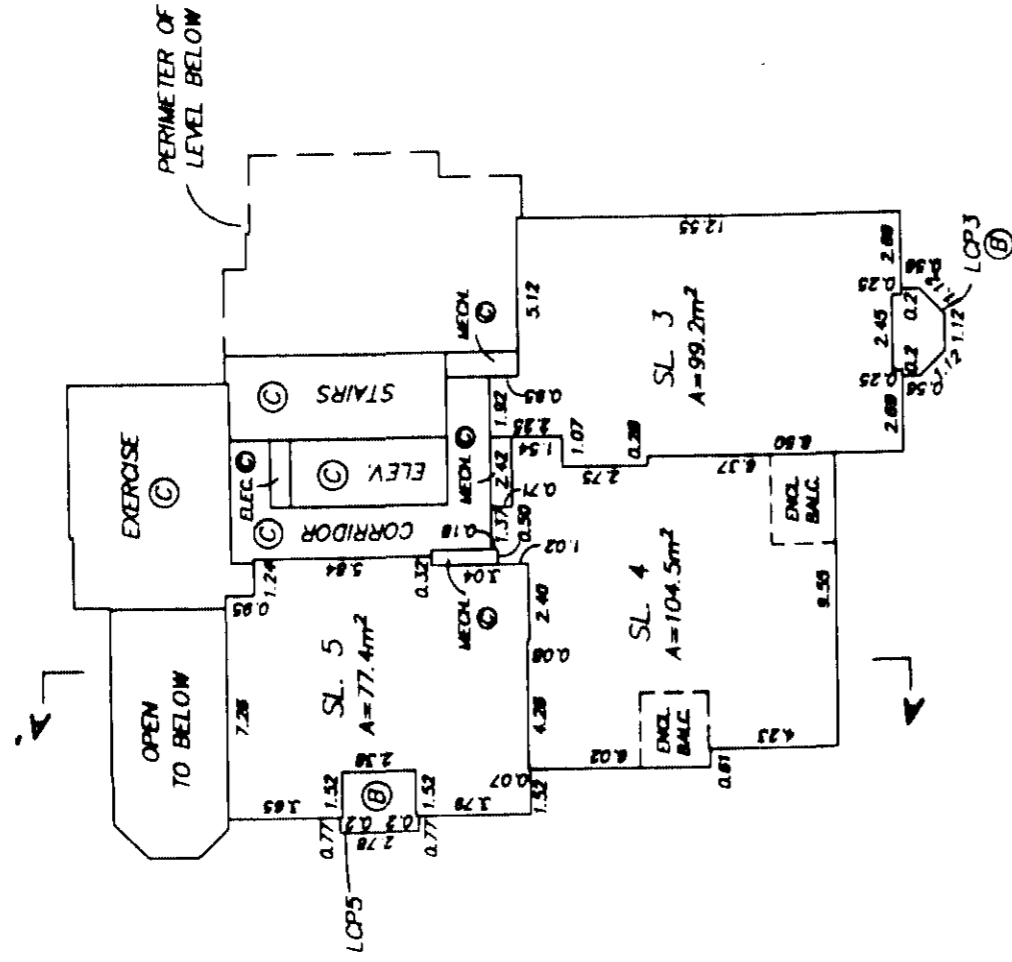

3rd FLOOR

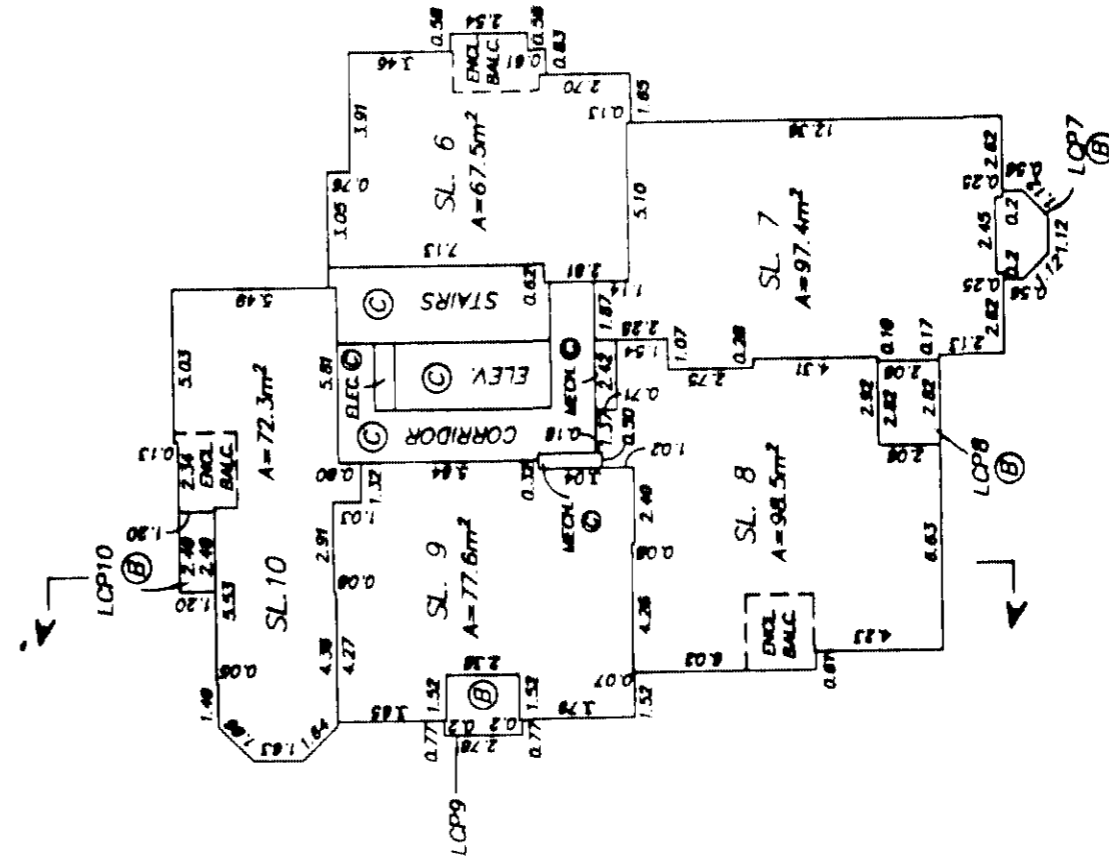

4th FLOOR

DATED THIS 13th DAY OF MAY, 2004.

[Signature] B.C.L.S.
FILE: 5267-P2 DISK: CD-1

SHEET 8 OF 20 SHEETS

FLOOR PLANS

STRATA PLAN BCS_856

SCALE 1 : 250

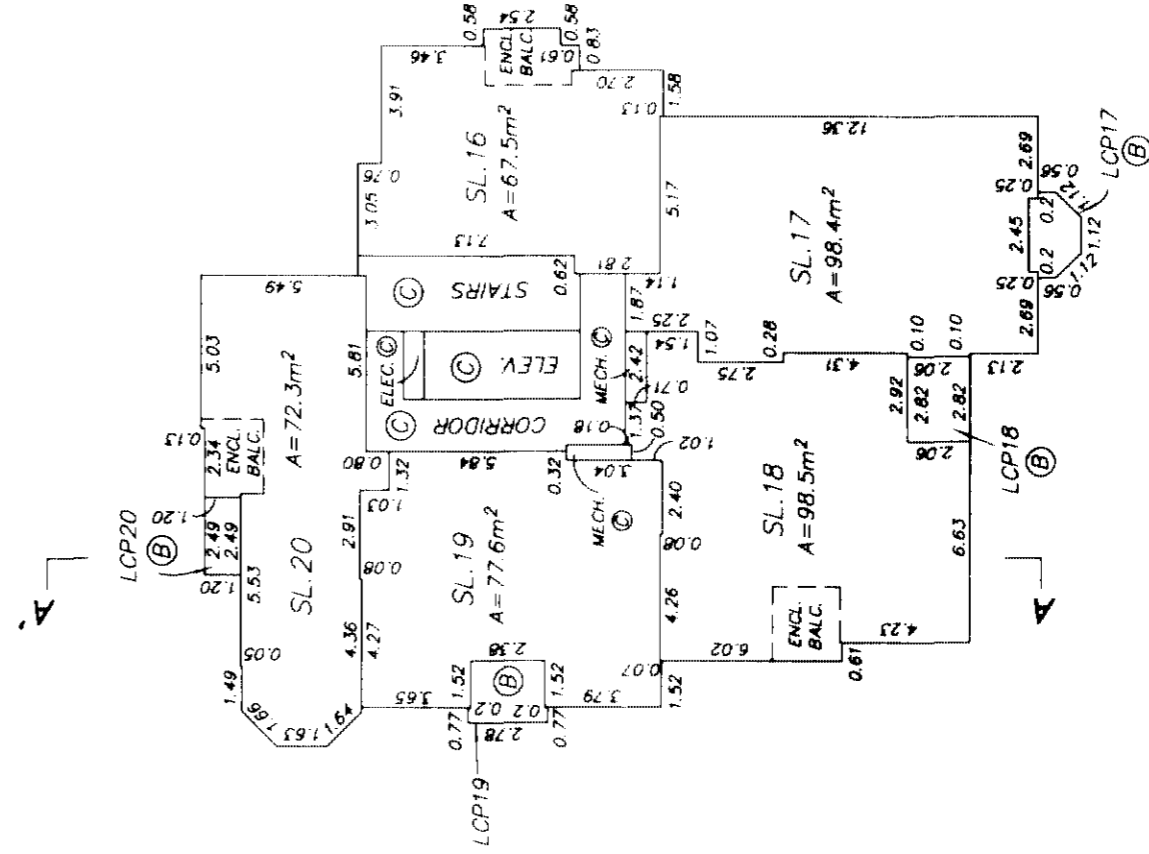
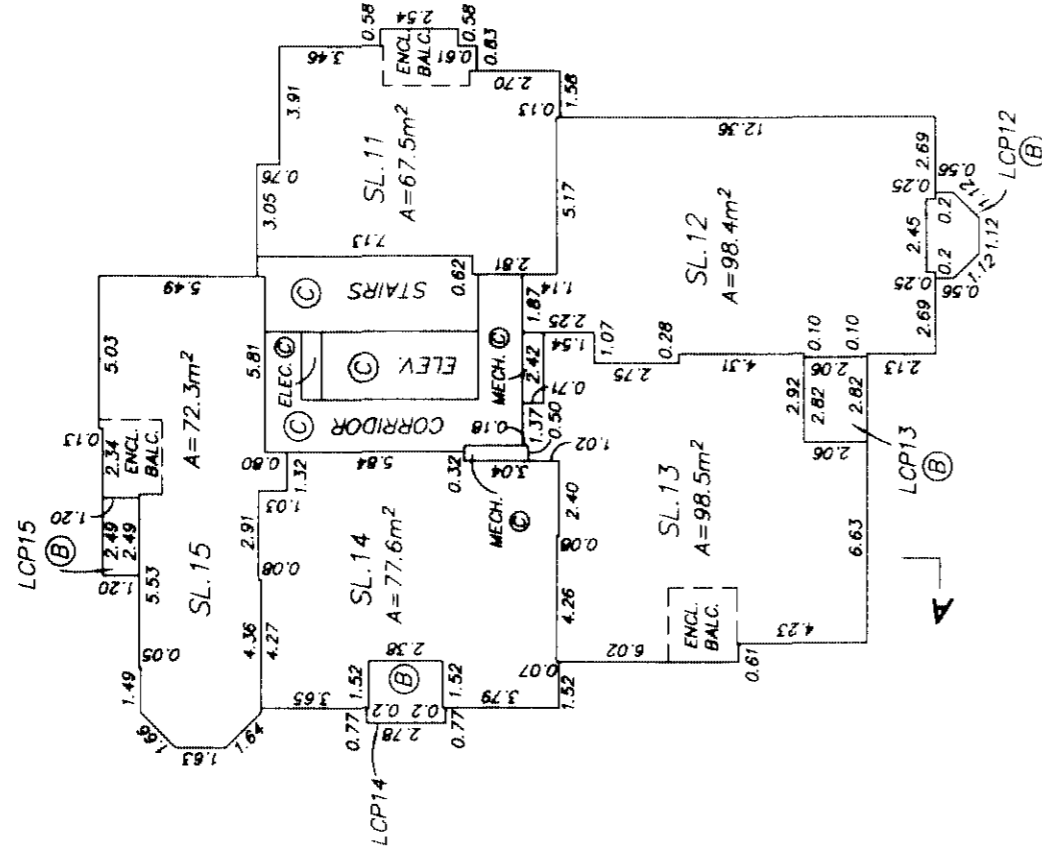
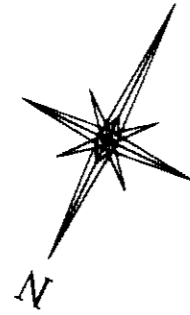
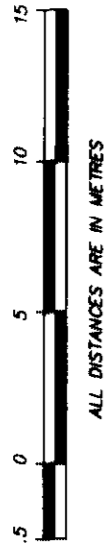

DATED THIS 13th DAY OF MAY, 2004.

[Signature]
 B.C.L.S.
 FILE: 5267-P2 DISK: CD-1

SHEET 9 OF 20 SHEETS

STRATA PLAN BCS 856

FLOOR PLANS

SCALE 1 : 250



ALL DISTANCES ARE IN METRES

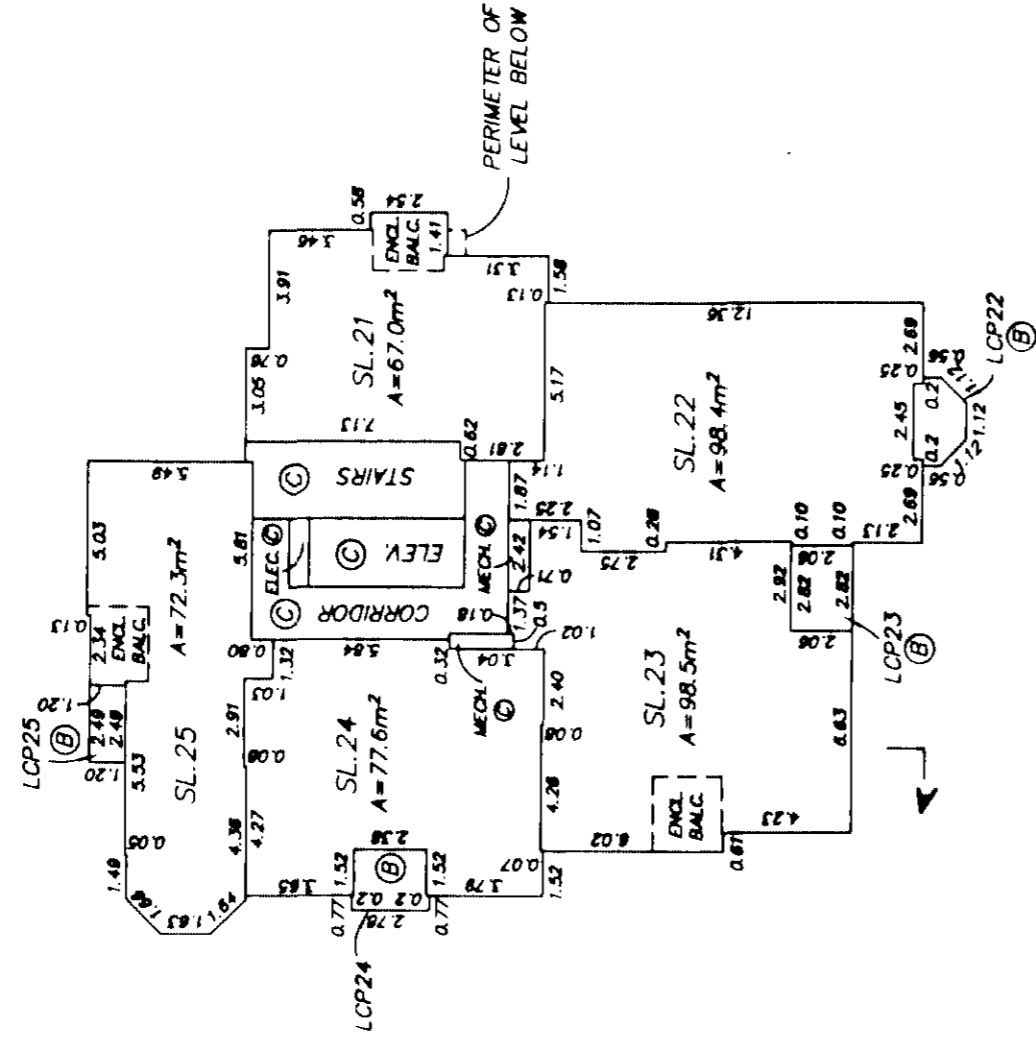

7th FLOOR

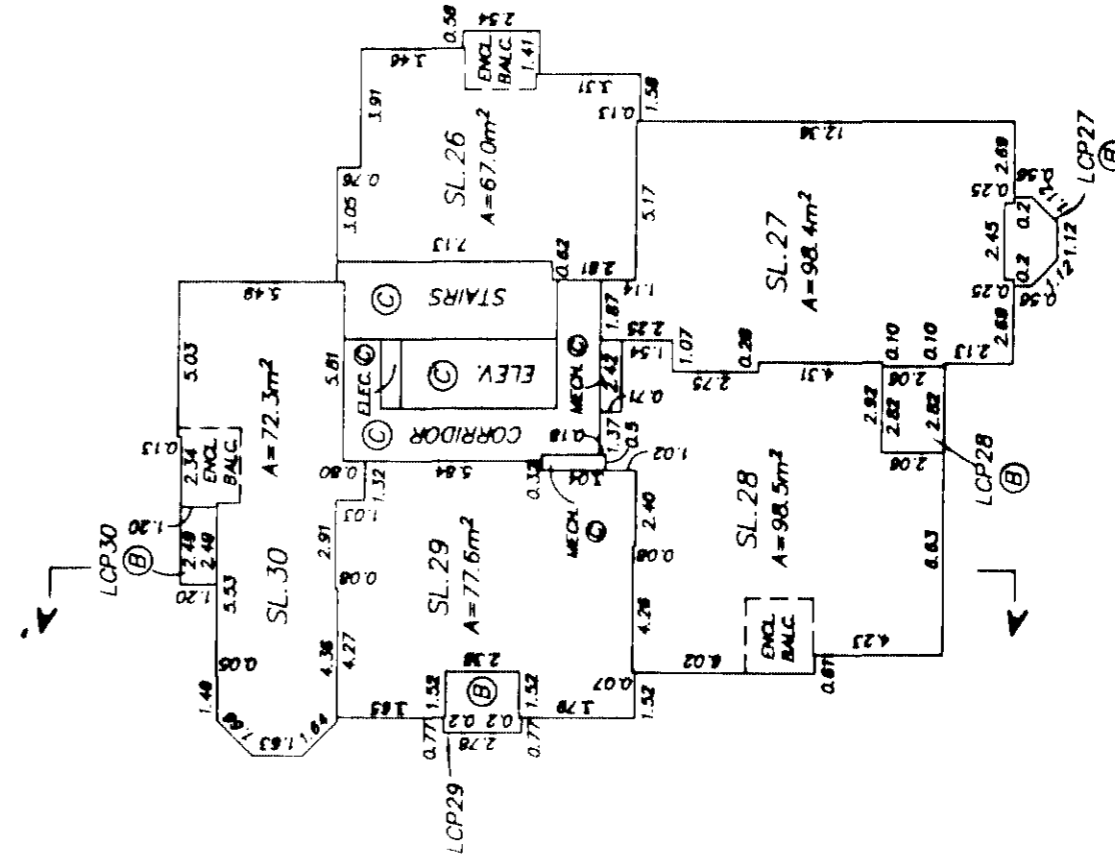

8th FLOOR

DATED THIS 13th DAY OF MAY, 2004.

B.C.L.S.

FILE: 5267-P2 DISK: CD-1

SHEET 10 OF 20 SHEETS

STRATA PLAN BCS 856

FLOOR PLANS

SCALE 1 : 250



ALL DISTANCES ARE IN METRES

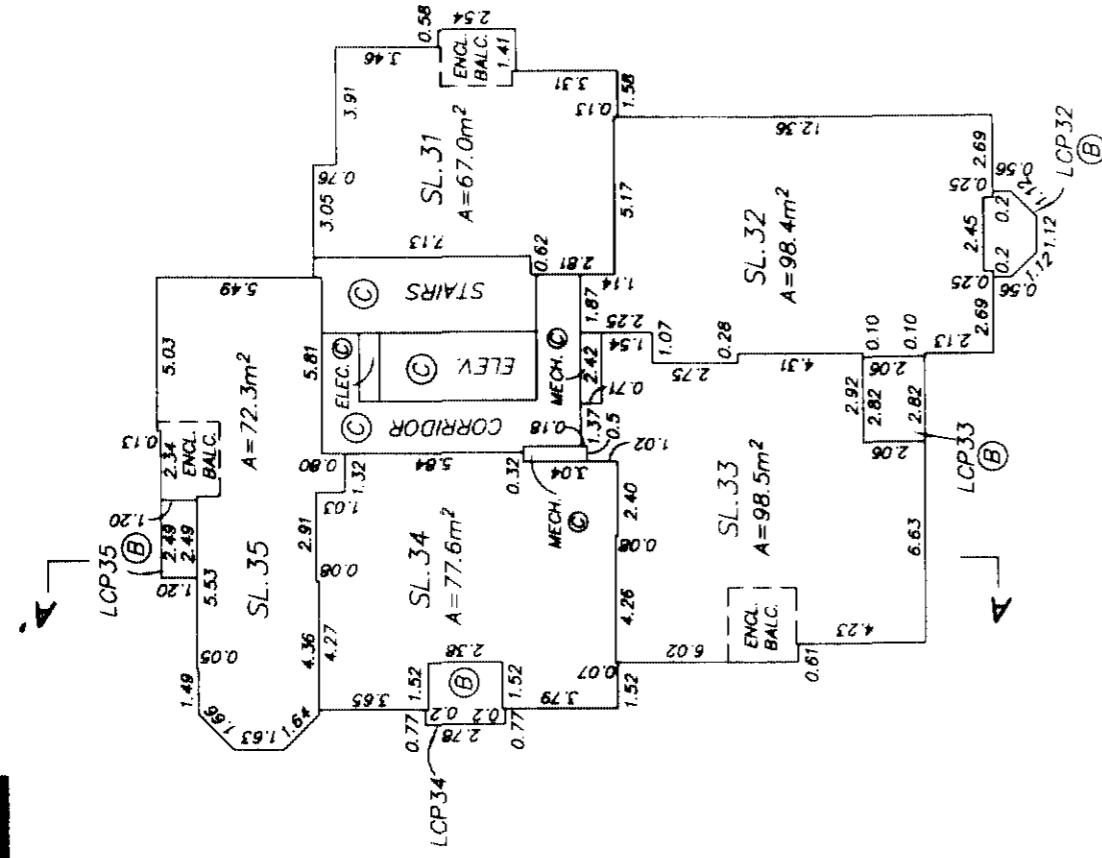
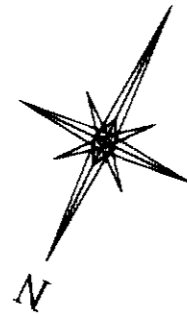

9th FLOOR

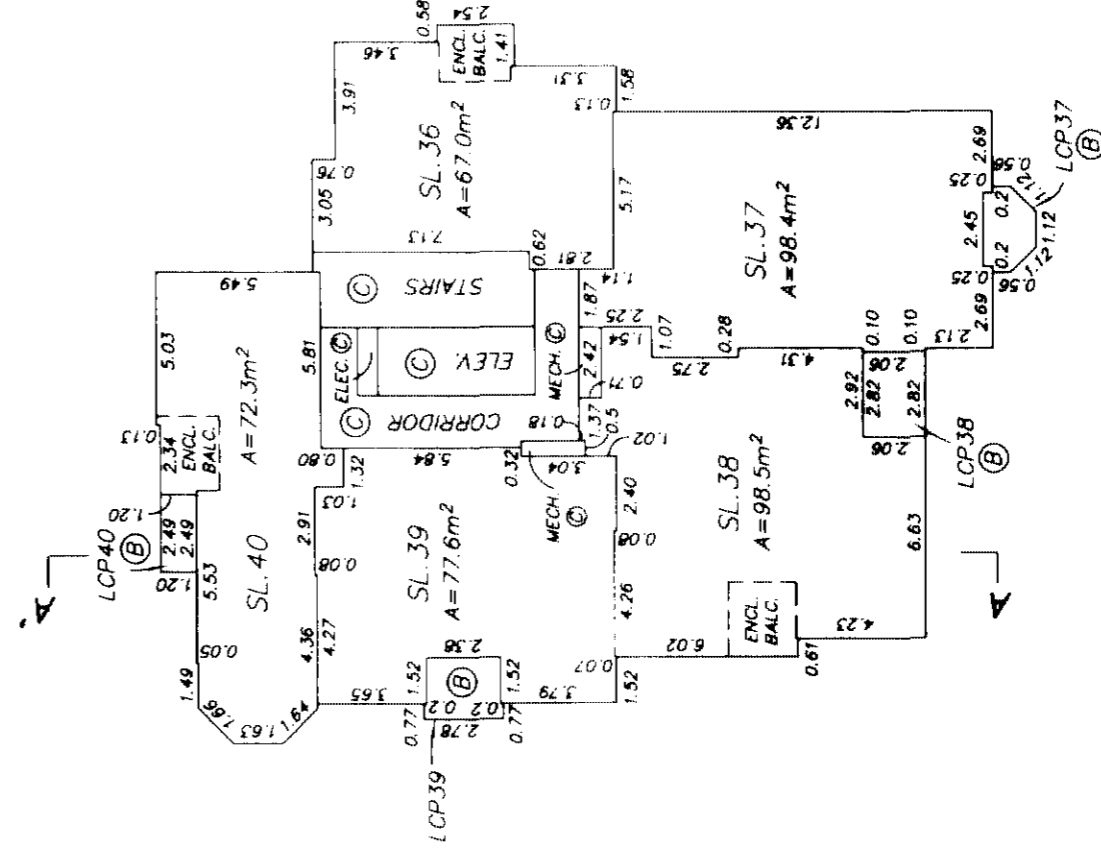

10th FLOOR

DATED THIS 13th DAY OF MAY, 2004.

[Signature] B.C.L.S.
 FILE: 5267-P2 DISK: CD-1

SHEET 11 OF 20 SHEETS

FLOOR PLANS

STRATA PLAN BCS 856

SCALE 1 : 250

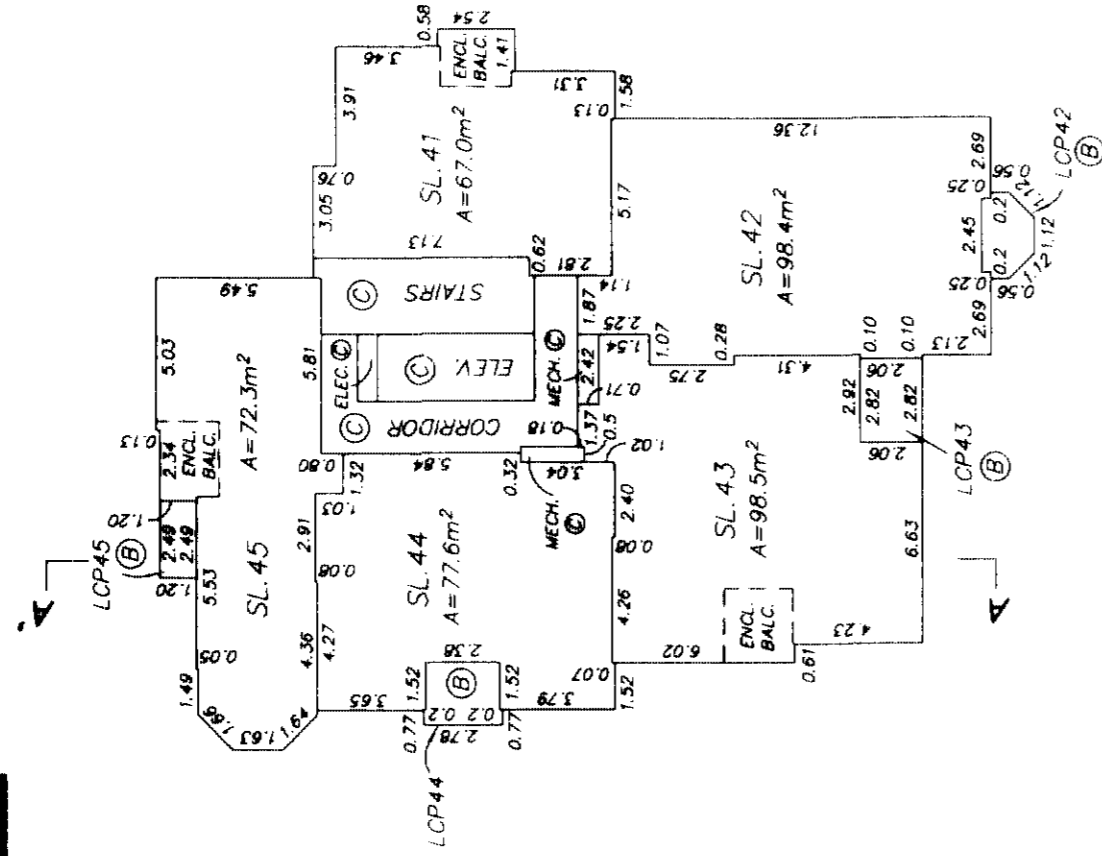
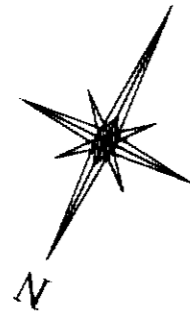

11th FLOOR

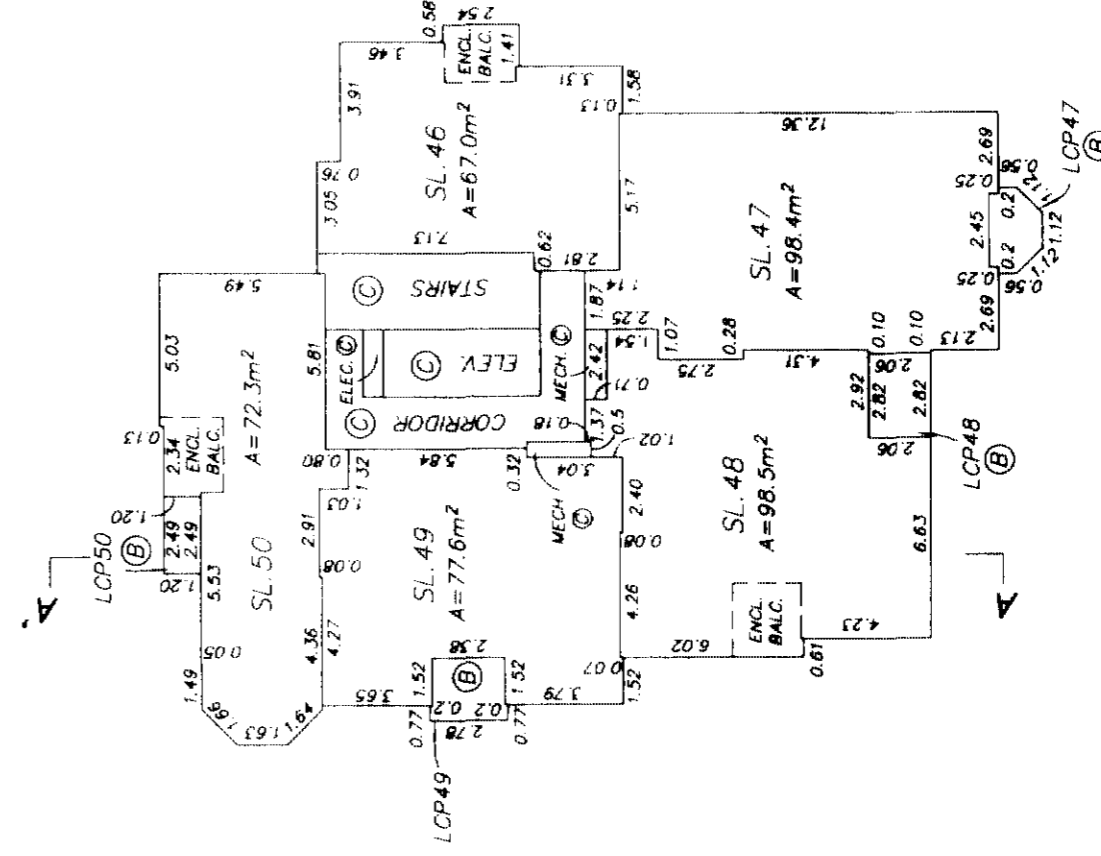

12th FLOOR

DATED THIS 13th DAY OF MAY, 2004.

[Signature]
 B.C.L.S.
 FILE: 5267-P2 DISK: CD-1

SHEET 12 OF 20 SHEETS

FLOOR PLANS

STRATA PLAN BCS_856

SCALE 1 : 250

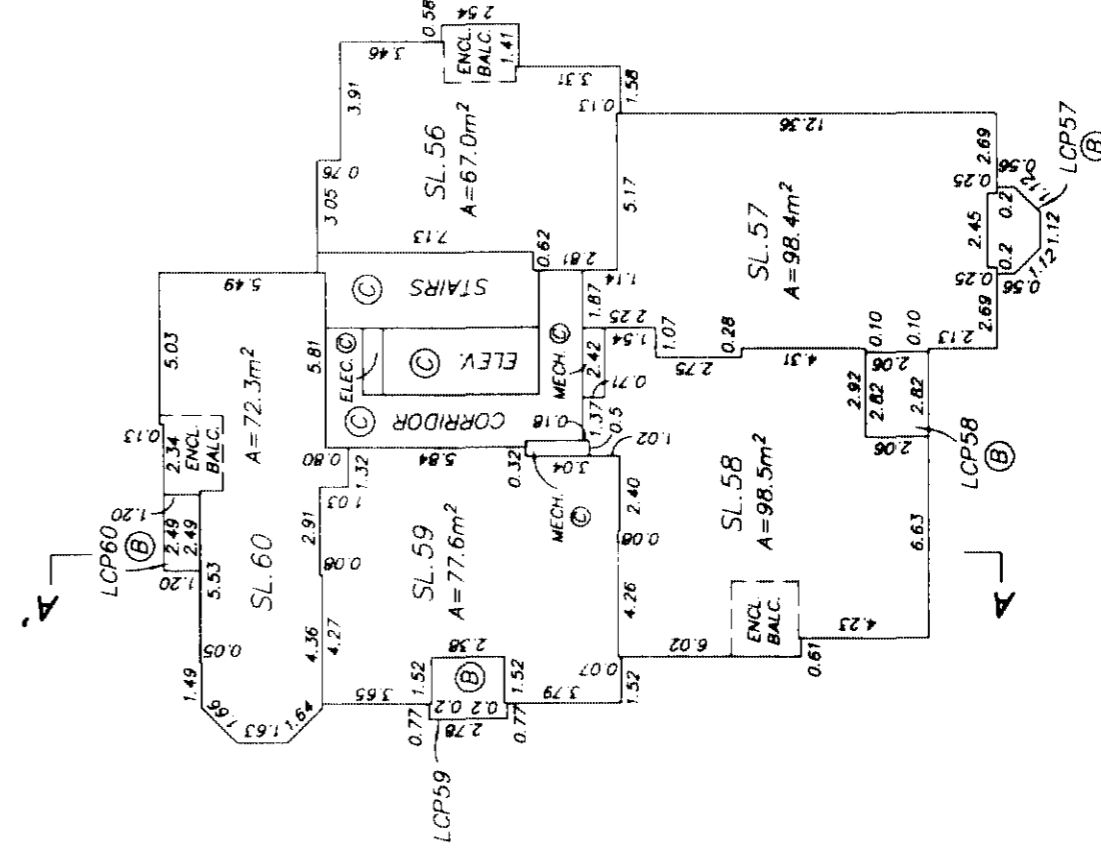
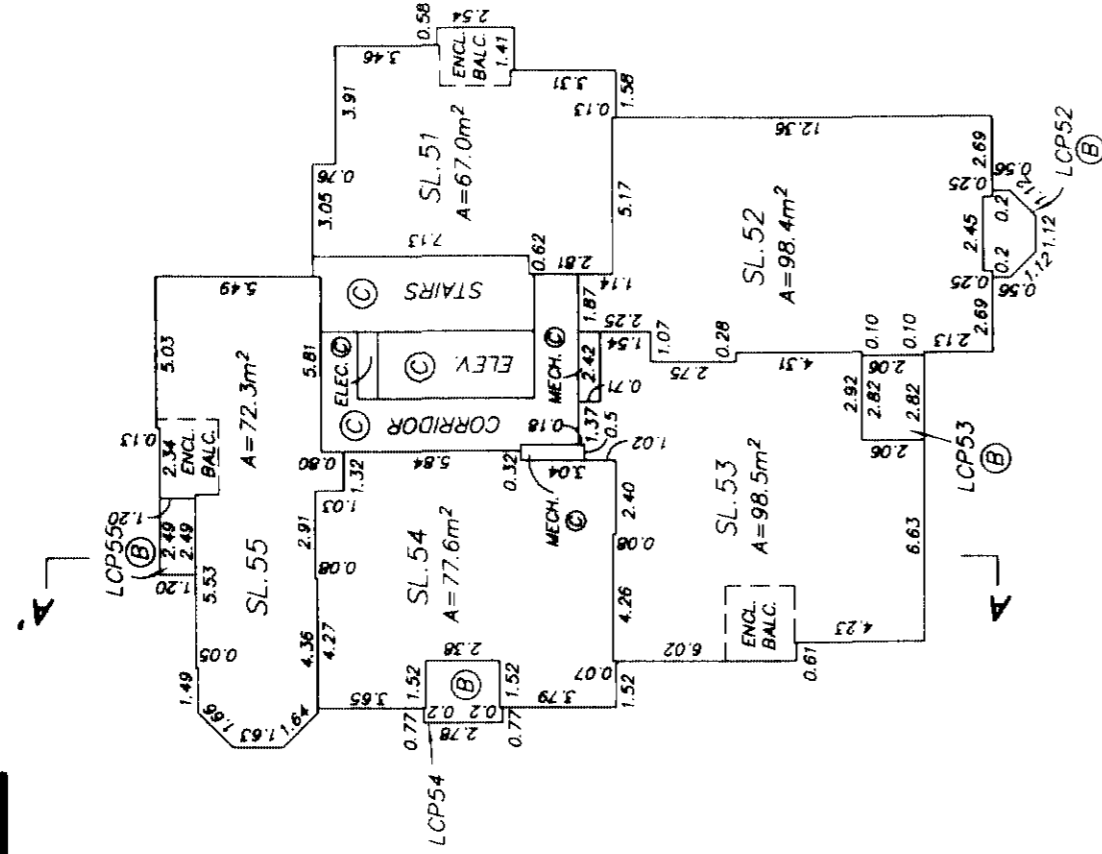
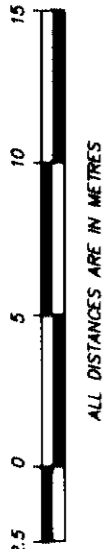

NOTE: THE 13th FLOOR HAS BEEN OMITTED.

DATED THIS 13th DAY OF MAY, 2004.

[Signature]
 B.C.L.S.
 FILE: 5267-P2 DISK: CD-1

SHEET 13 OF 20 SHEETS

FLOOR PLANS

STRATA PLAN BCS 856

SCALE 1 : 250



ALL DISTANCES ARE IN METRES

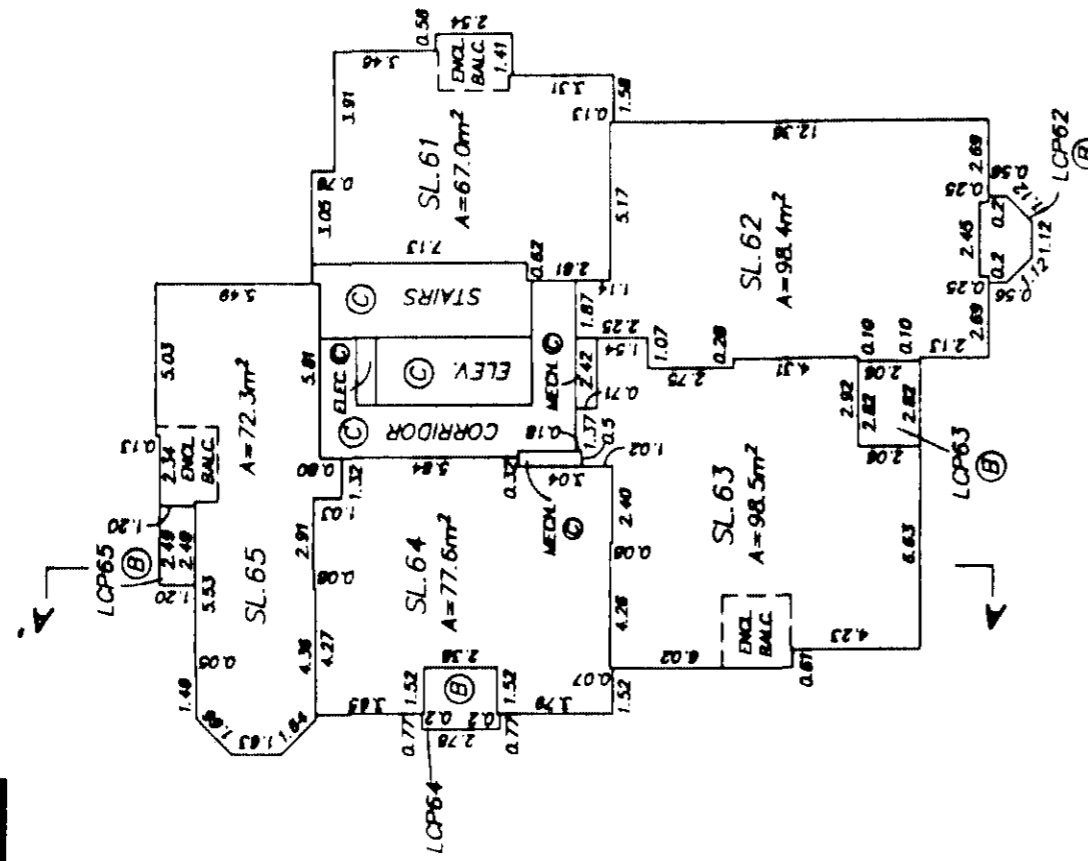

16th FLOOR

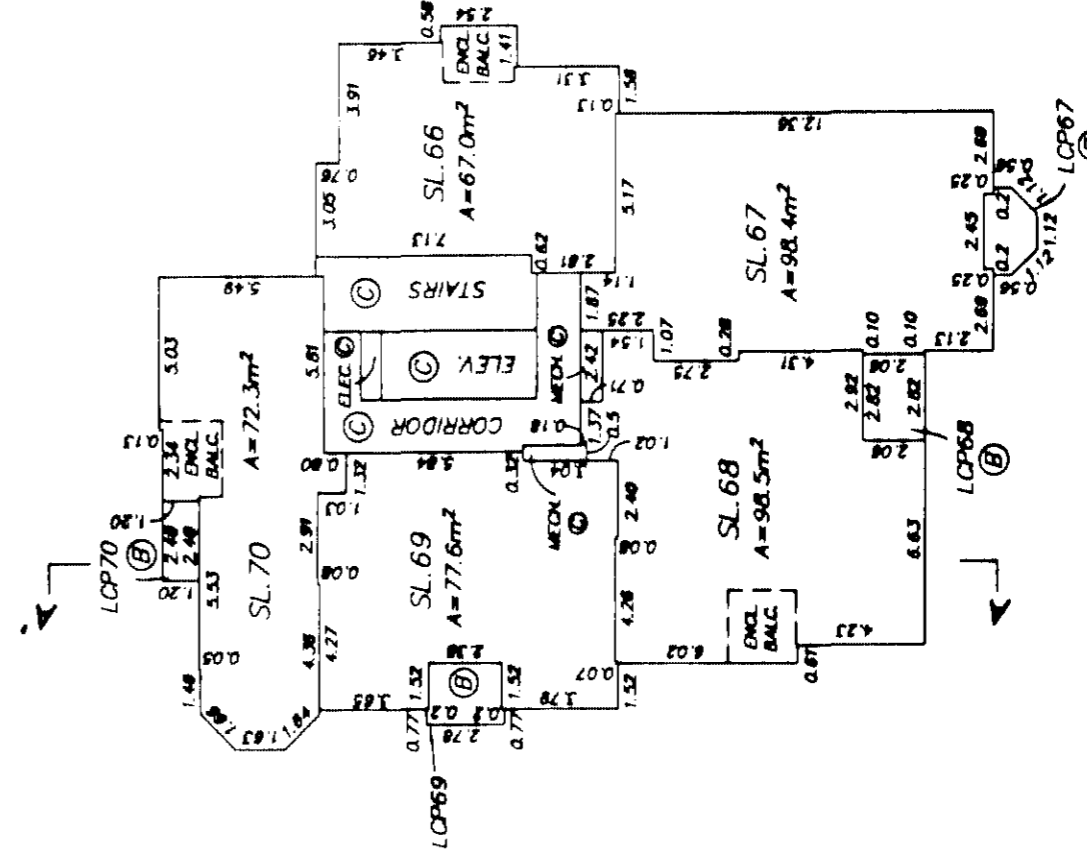

17th FLOOR

DATED THIS 13th DAY OF MAY, 2004.

FILE: 5267-P2 DISK: CD-1

B.C.L.S.

Handwritten signature

SHEET 14 OF 20 SHEETS

FLOOR PLANS

STRATA PLAN BCS_856

SCALE 1 : 250

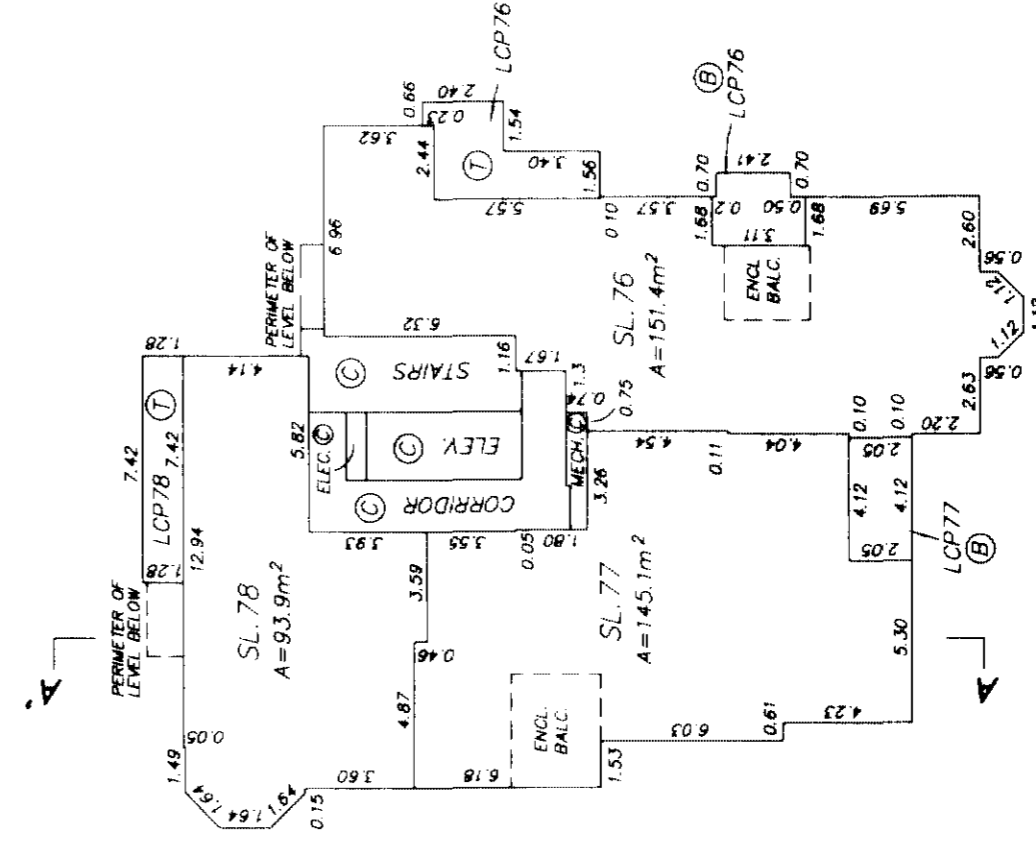
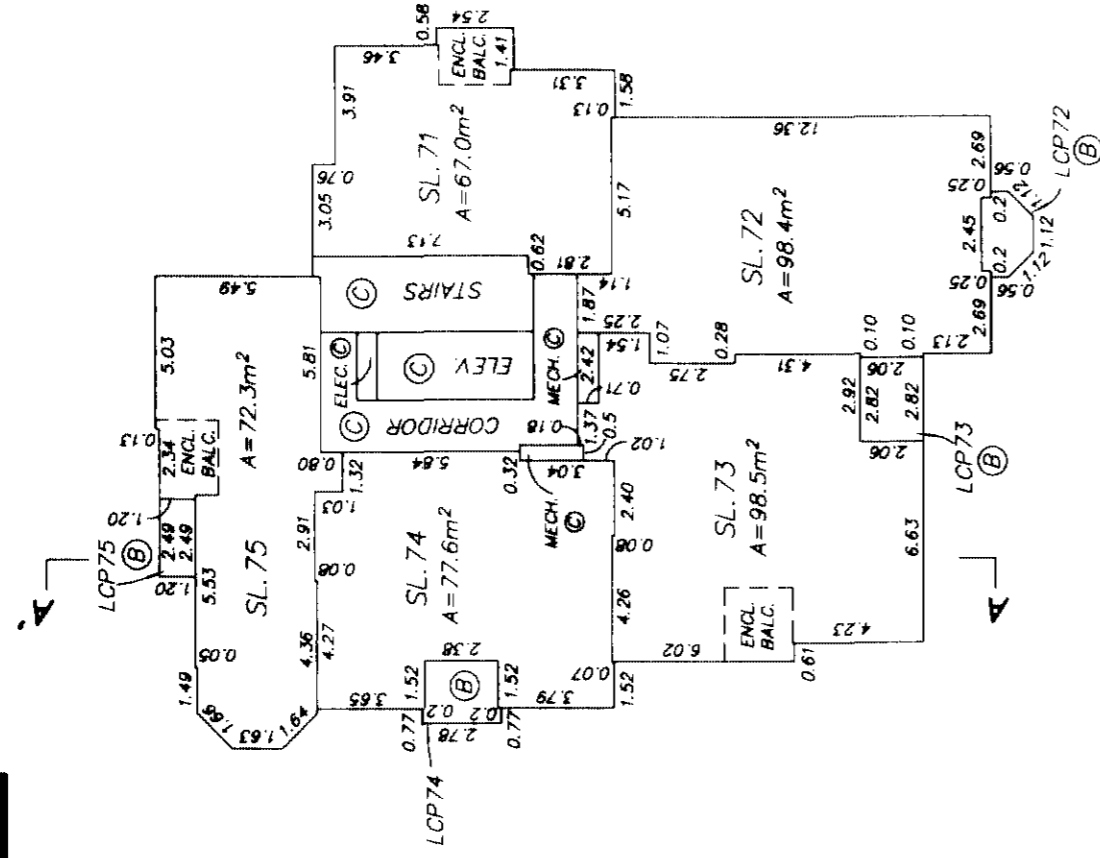
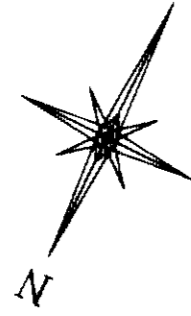
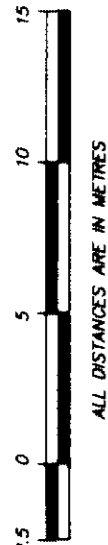

DATED THIS 13th DAY OF MAY, 2004.

B.C.L.S.

FILE: 5267-P2 DISK: CD-1

SHEET 15 OF 20 SHEETS

STRATA PLAN BCS 856

FLOOR PLANS

SCALE 1 : 250



ALL DISTANCES ARE IN METRES

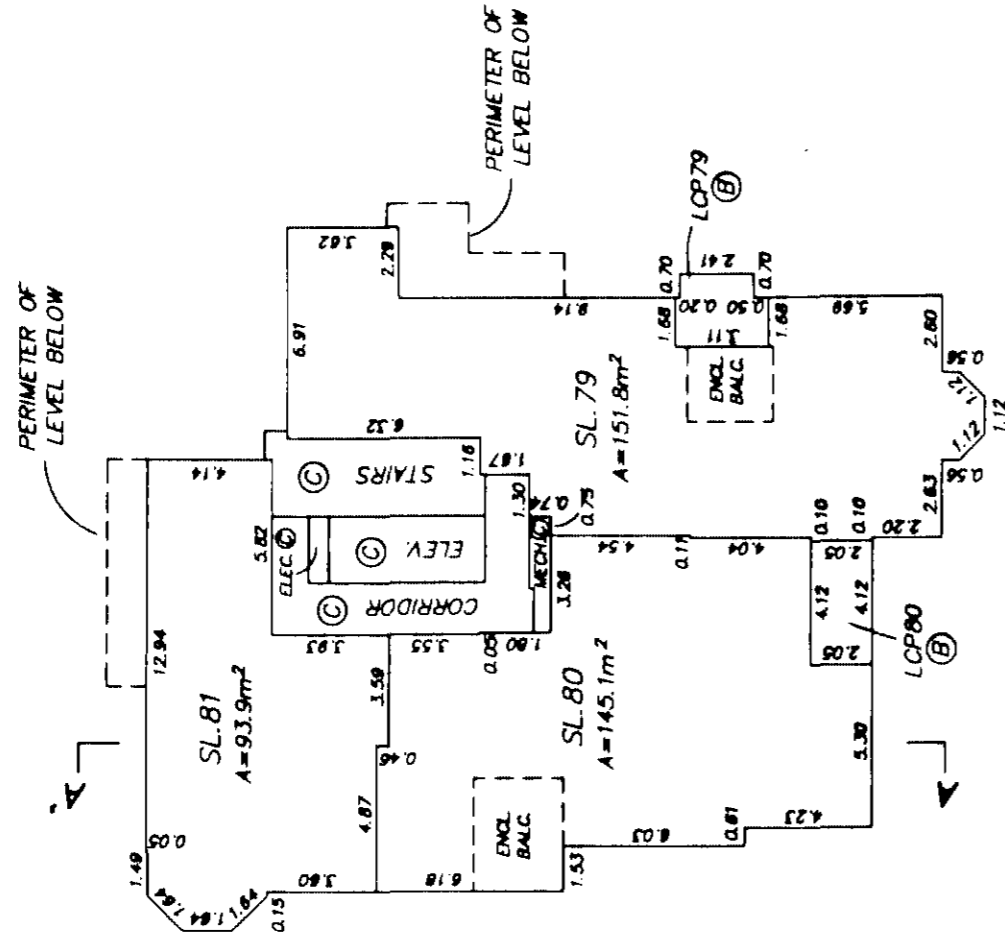

20th FLOOR

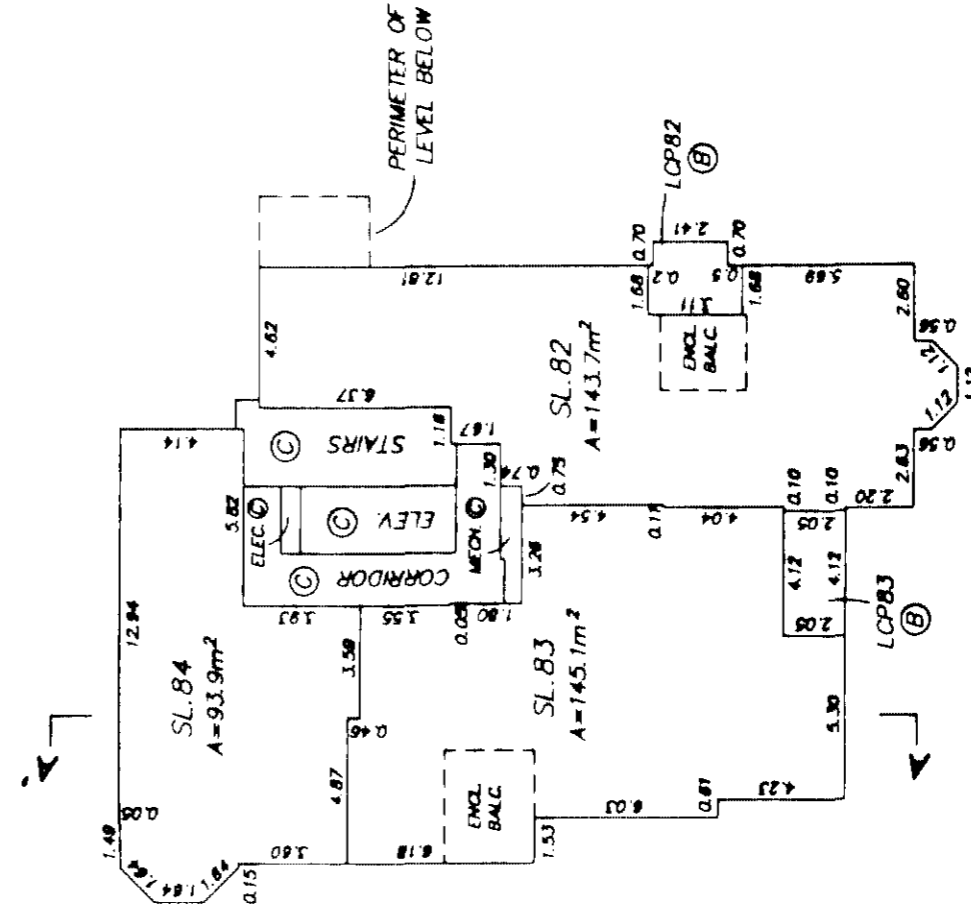

21st FLOOR

DATED THIS 13th DAY OF MAY, 2004.

[Signature]
B.C.L.S.

FILE: 5267-P2 DISK: CD-1

SHEET 16 OF 20 SHEETS

FLOOR PLANS

STRATA PLAN BCS_856

SCALE 1 : 250

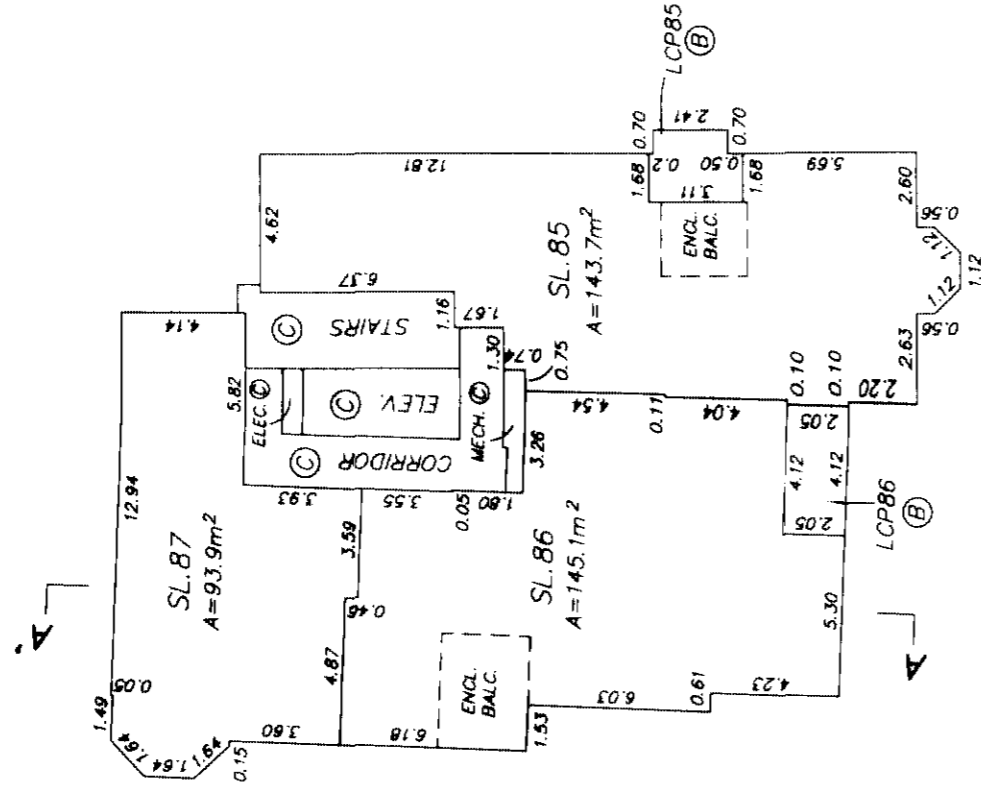
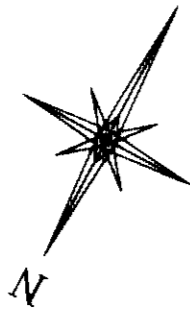
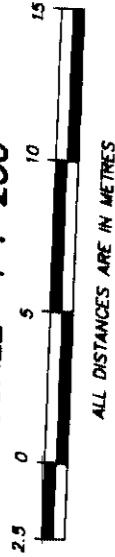

22nd FLOOR

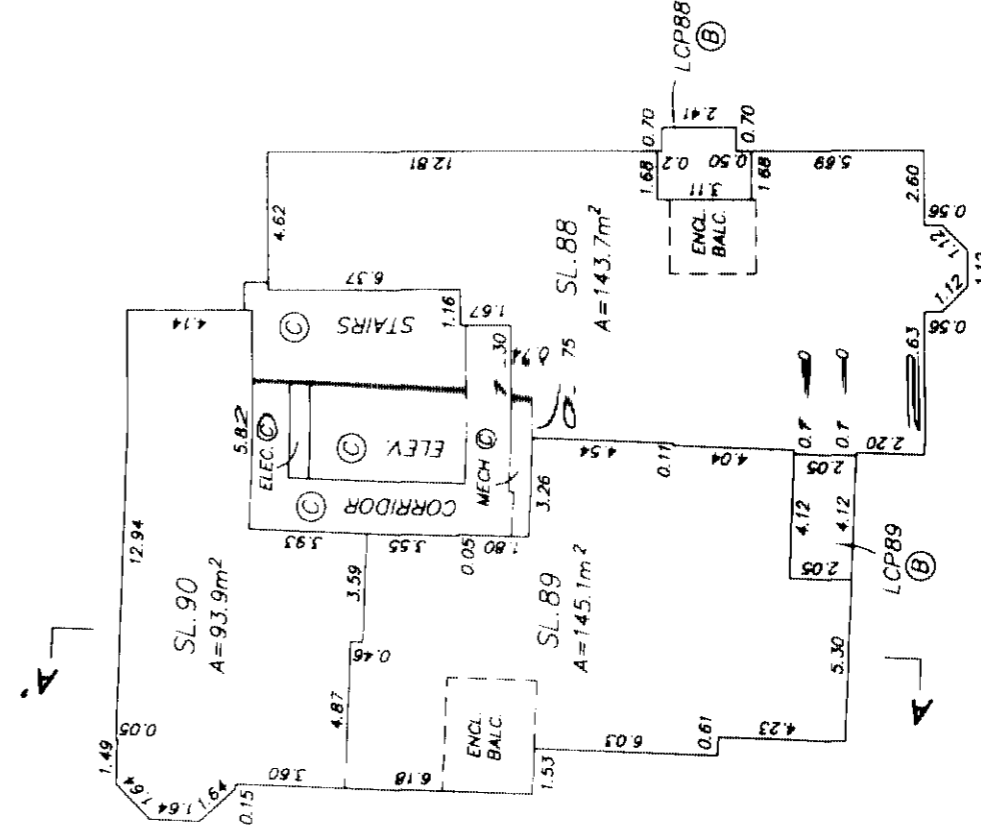

23rd FLOOR

DATED THIS 13th DAY OF MAY, 2004.

FILE: 5267-P2 DISK: CD-1

SHEET 17 OF 20 SHEETS

STRATA PLAN BCS 856

FLOOR PLANS

SCALE 1 : 250



ALL DISTANCES ARE IN METRES

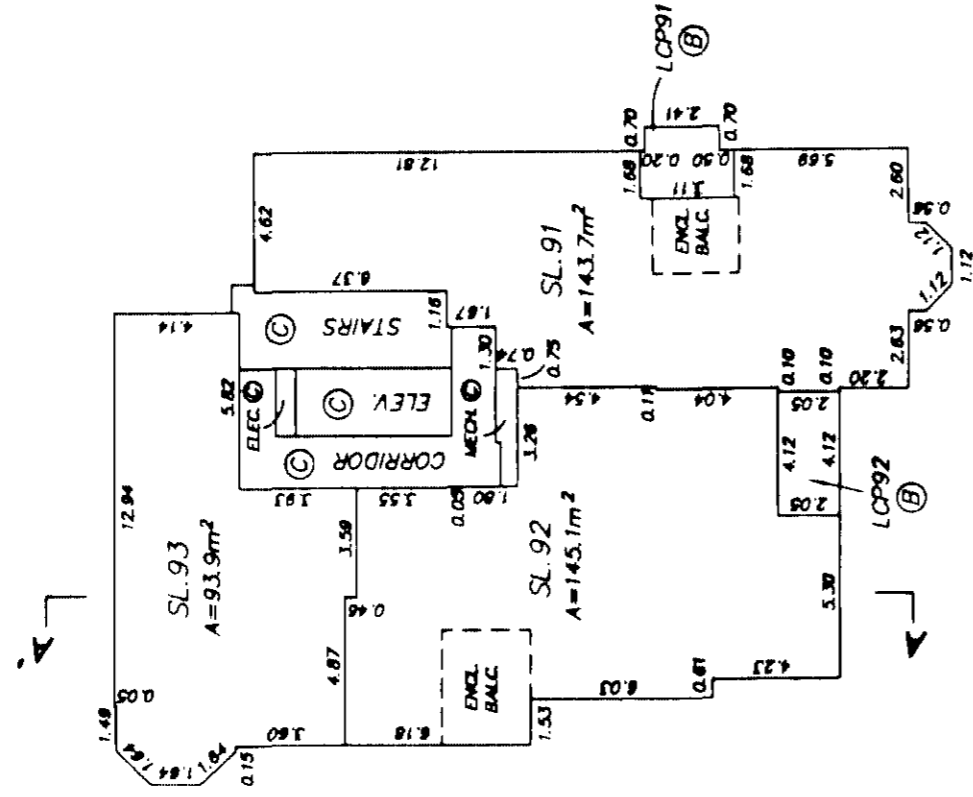

24th FLOOR

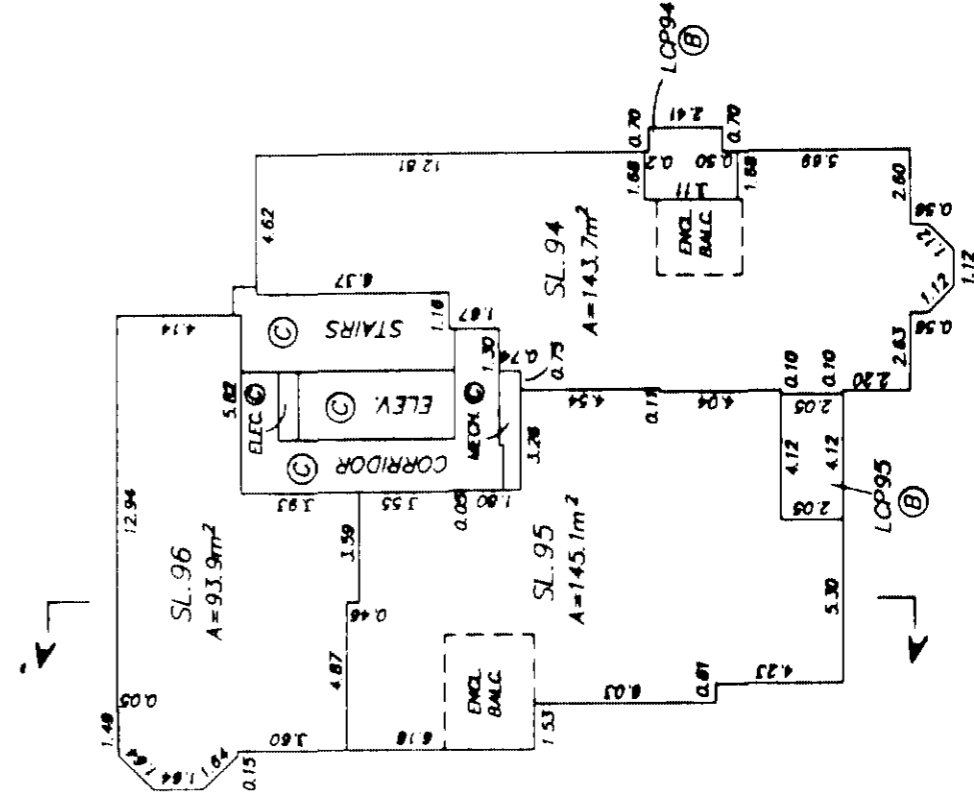

25th FLOOR

DATED THIS 13th DAY OF MAY, 2004.

[Signature]
 B.C.L.S.
 FILE: 5267-P2 DISK: CD-1

SHEET 18 OF 20 SHEETS

STRATA PLAN BCS 856

FLOOR PLANS

SCALE 1 : 250



ALL DISTANCES ARE IN METRES

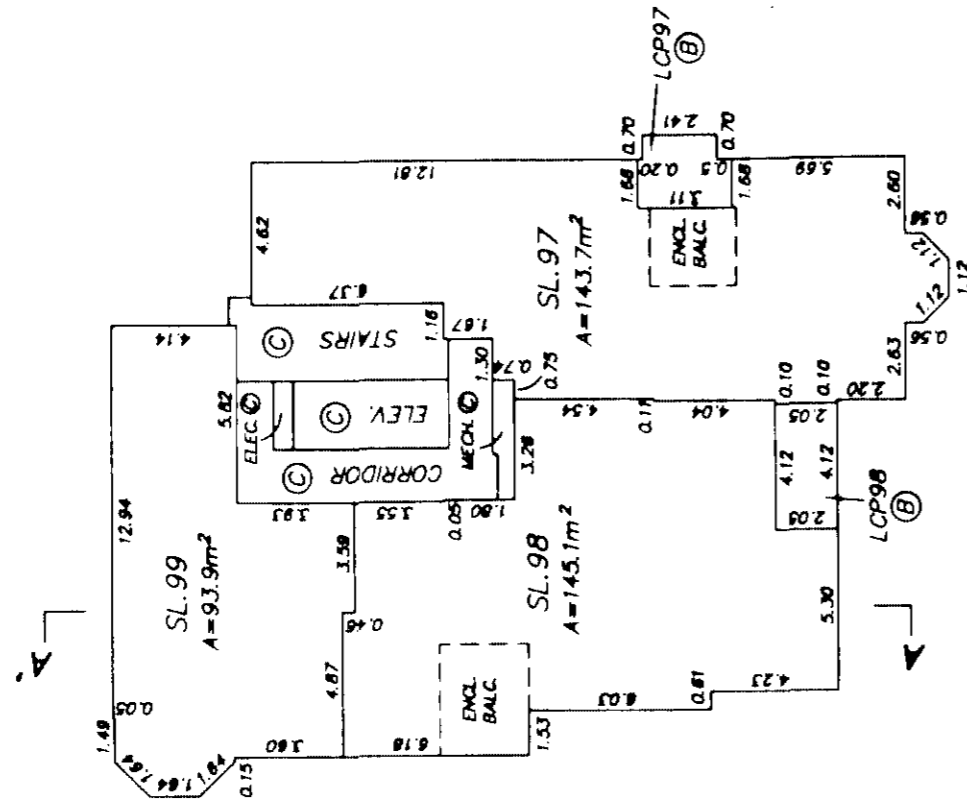

26th FLOOR

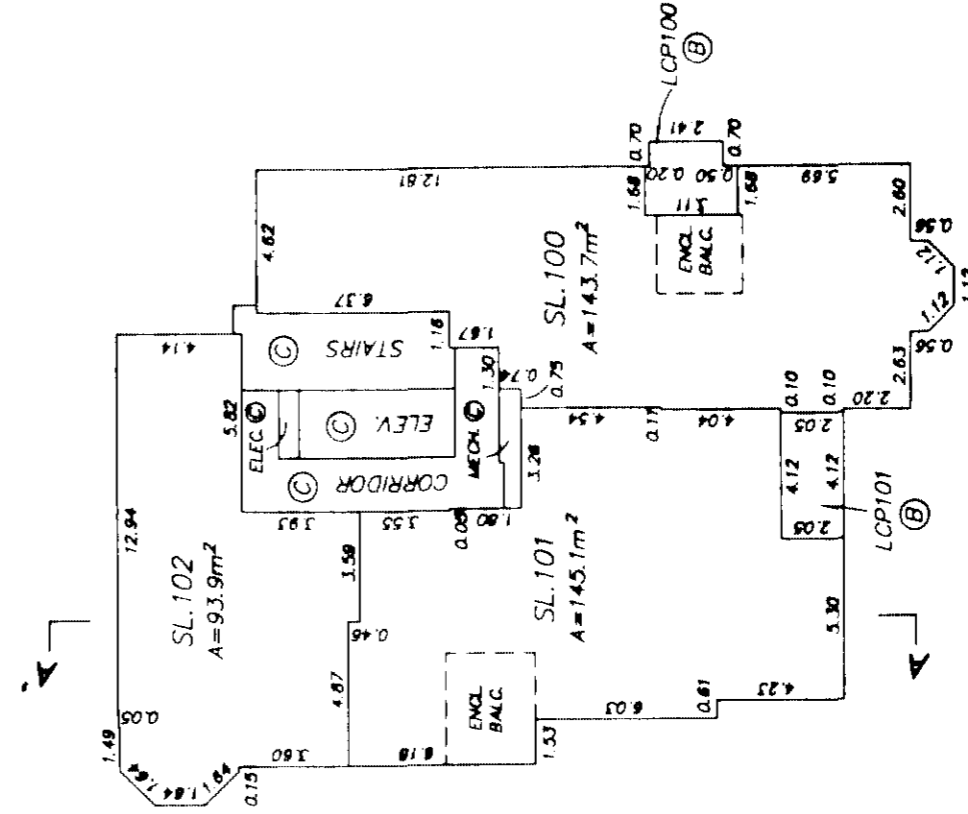

27th FLOOR

DATED THIS 13th DAY OF MAY, 2004.

[Signature] B.C.L.S.

FILE: 5267-P2 DISK: CO-1

SHEET 19 OF 20 SHEETS

FLOOR PLANS

STRATA PLAN BCS 856

SCALE 1 : 250



ALL DISTANCES ARE IN METRES

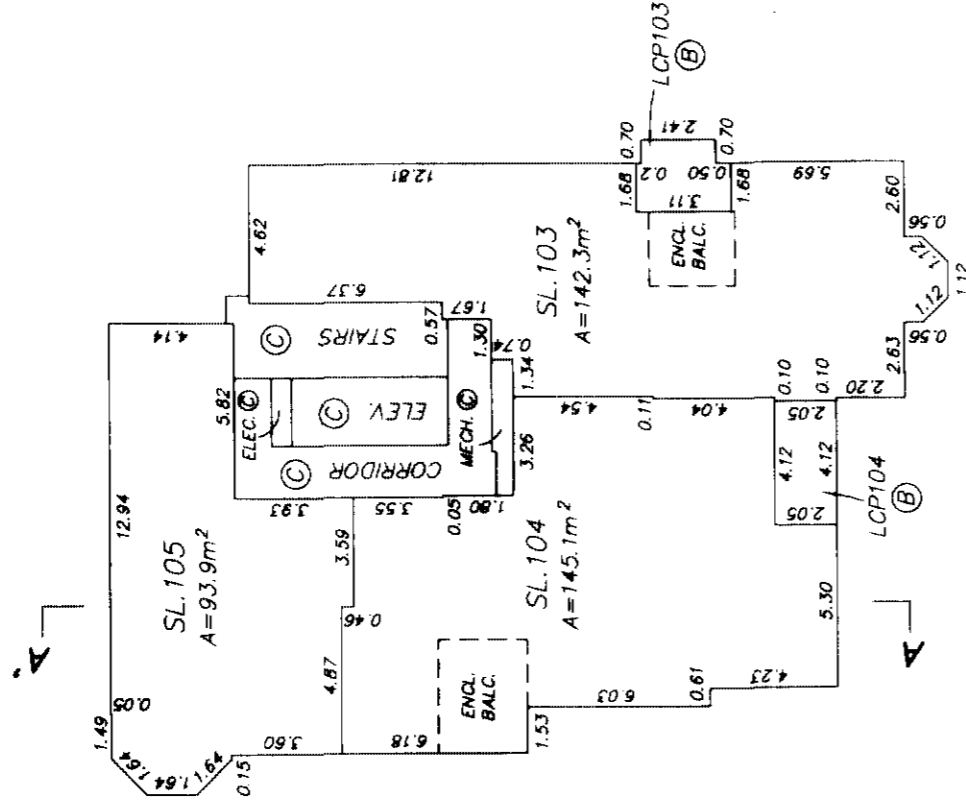

28th FLOOR

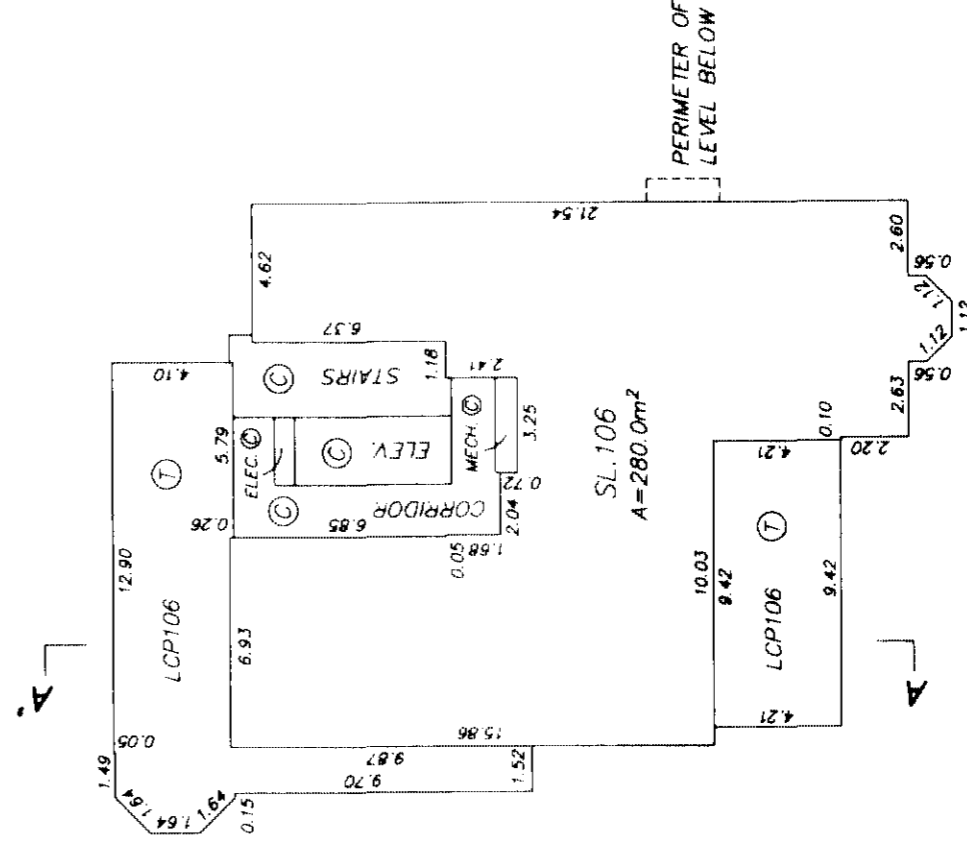

29th FLOOR

DATED THIS 13th DAY OF MAY, 2004.

Signature and text: B.C.L.S. FILE: 6267-P2 DISK: CD-1

SHEET 20 OF 20 SHEETS

SECTION A - A'

STRATA PLAN BCS 856

SCALE 1 : 250



ALL DISTANCES ARE IN METRES

NOTE: THE 13th FLOOR HAS BEEN OMITTED.

29th FLOOR	LCP106	SL.106	
28th FLOOR	LCP70	SL.104	SL.105
27th FLOOR	LCP65	SL.101	SL.102
26th FLOOR	LCP60	SL.98	SL.99
25th FLOOR	LCP55	SL.95	SL.96
24th FLOOR	LCP50	SL.92	SL.93
23rd FLOOR	LCP45	SL.89	SL.90
22nd FLOOR	LCP40	SL.86	SL.87
21st FLOOR	LCP35	SL.83	SL.84
20th FLOOR	LCP30	SL.80	SL.81
19th FLOOR	LCP25	SL.77	SL.78
18th FLOOR	LCP20	SL.73	SL.74
17th FLOOR	LCP15	SL.68	SL.69
	LCP10	SL.70	

18th FLOOR	LCP75	SL.73	SL.74	AMENITY	LOCKERS	LOCKERS	LOCKERS
17th FLOOR	LCP70	SL.68	SL.69	AMENITY	LOCKERS	LOCKERS	LOCKERS
16th FLOOR	LCP65	SL.63	SL.64	AMENITY	LOCKERS	LOCKERS	LOCKERS
15th FLOOR	LCP60	SL.58	SL.59	AMENITY	LOCKERS	LOCKERS	LOCKERS
14th FLOOR	LCP55	SL.53	SL.54	AMENITY	LOCKERS	LOCKERS	LOCKERS
12th FLOOR	LCP50	SL.48	SL.49	AMENITY	LOCKERS	LOCKERS	LOCKERS
11th FLOOR	LCP45	SL.43	SL.44	AMENITY	LOCKERS	LOCKERS	LOCKERS
10th FLOOR	LCP40	SL.38	SL.39	AMENITY	LOCKERS	LOCKERS	LOCKERS
9th FLOOR	LCP35	SL.33	SL.34	AMENITY	LOCKERS	LOCKERS	LOCKERS
8th FLOOR	LCP30	SL.28	SL.29	AMENITY	LOCKERS	LOCKERS	LOCKERS
7th FLOOR	LCP25	SL.23	SL.24	AMENITY	LOCKERS	LOCKERS	LOCKERS
6th FLOOR	LCP20	SL.18	SL.19	AMENITY	LOCKERS	LOCKERS	LOCKERS
5th FLOOR	LCP15	SL.13	SL.14	AMENITY	LOCKERS	LOCKERS	LOCKERS
4th FLOOR	LCP10	SL.8	SL.9	AMENITY	LOCKERS	LOCKERS	LOCKERS
3rd FLOOR		SL.4	SL.5	AMENITY	LOCKERS	LOCKERS	LOCKERS
2nd FLOOR		SL.1	SL.2	AMENITY	LOCKERS	LOCKERS	LOCKERS
GROUND FLOOR				AMENITY	LOCKERS	LOCKERS	LOCKERS
LEVEL P-2				AMENITY	LOCKERS	LOCKERS	LOCKERS
LEVEL P-3				AMENITY	LOCKERS	LOCKERS	LOCKERS

DATED THIS 13th DAY OF MAY, 2004.

B.C.L.S.
FILE: 5267-P2 DISK: CD-1