

STRATA PLAN BCS 1465

OWNER:

TIEN SHER INVESTMENT GROUP INC. (INC.NO. 681647)

AUTHORIZED SIGNATORY: CHARAN S. SETHI

Witness (SIGN & PRINT NAME) Pete Stringer

Address of 7981 17th Avenue
Witness: Burnaby, BC V3N 1M4

Occupation of
Witness: Development

MORTGAGEE:

COAST CAPITAL SAVINGS CREDIT UNION

AUTHORIZED SIGNATORY (SIGN & PRINT NAME)
SALIM BANO

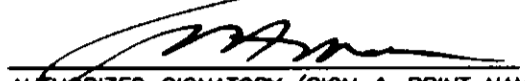
AUTHORIZED SIGNATORY (SIGN & PRINT NAME)
ROD HARE



Witness as to both signatures (SIGN & PRINT NAME)

Address of 800 - 5611 COONEY ROAD
Witness: RICHMOND, BC V6X 3J5

Occupation of
Witness: ASSISIAN, REAL ESTATE AGENT

The City of Richmond, the registered owner of covenant AC100807 and BW553760, hereby consent to the deposit of this plan.

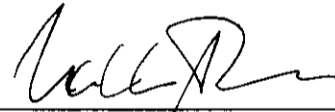
PARTY(IES) SIGNATURE(S)
CITY OF RICHMOND BY ITS
AUTHORIZED SIGNATORIES

MAYOR, MALCOLM D. BRODIE
AUTHORIZED SIGNATORY

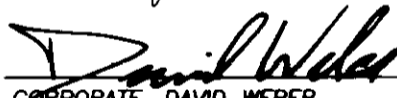

CORPORATE, DAVID WEBER
AUTHORIZED SIGNATORY

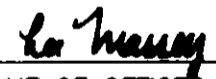
OFFICER SIGNATURE(S)

NAME OF OFFICER:
LEE MASSEY
COMMISSIONER FOR TAKING AFFIDAVITS
CITY OF RICHMOND
6911 NUMBER 3 ROAD
RICHMOND, B.C.
V6Y 2C1
PHONE: (604) 276-4000
AS TO THE SIGNATURE OF DAVID WEBER

THIS 23 DAY OF AUGUST, 2005.

OFFICER CERTIFICATION: YOUR SIGNATURE CONSTITUTES A REPRESENTATION THAT YOU ARE A SOLICITOR, NOTARY PUBLIC OR OTHER PERSON AUTHORIZED BY THE EVIDENCE ACT. R.S.B.C. 1996, C. 124, TO TAKE AFFIDAVITS FOR USE IN BRITISH COLUMBIA AND CERTIFIES THE MATTERS SET OUT IN PART 5 OF THE LAND TITLE ACT AS THEY PERTAIN TO THE EXECUTION OF THIS INSTRUMENT.



JOHNSON C. TAM, B.C.L.S.

August 18th, 2005.

BUILDING 2
STRATA LOTS 1 AND 2

STRATA PLAN BCS 1465

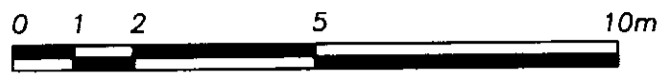
SCALE: 1:125



ALL DISTANCES ARE IN METRES AND DECIMALS THEREOF UNLESS OTHERWISE INDICATED

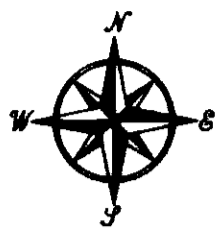

GROUND FLOOR

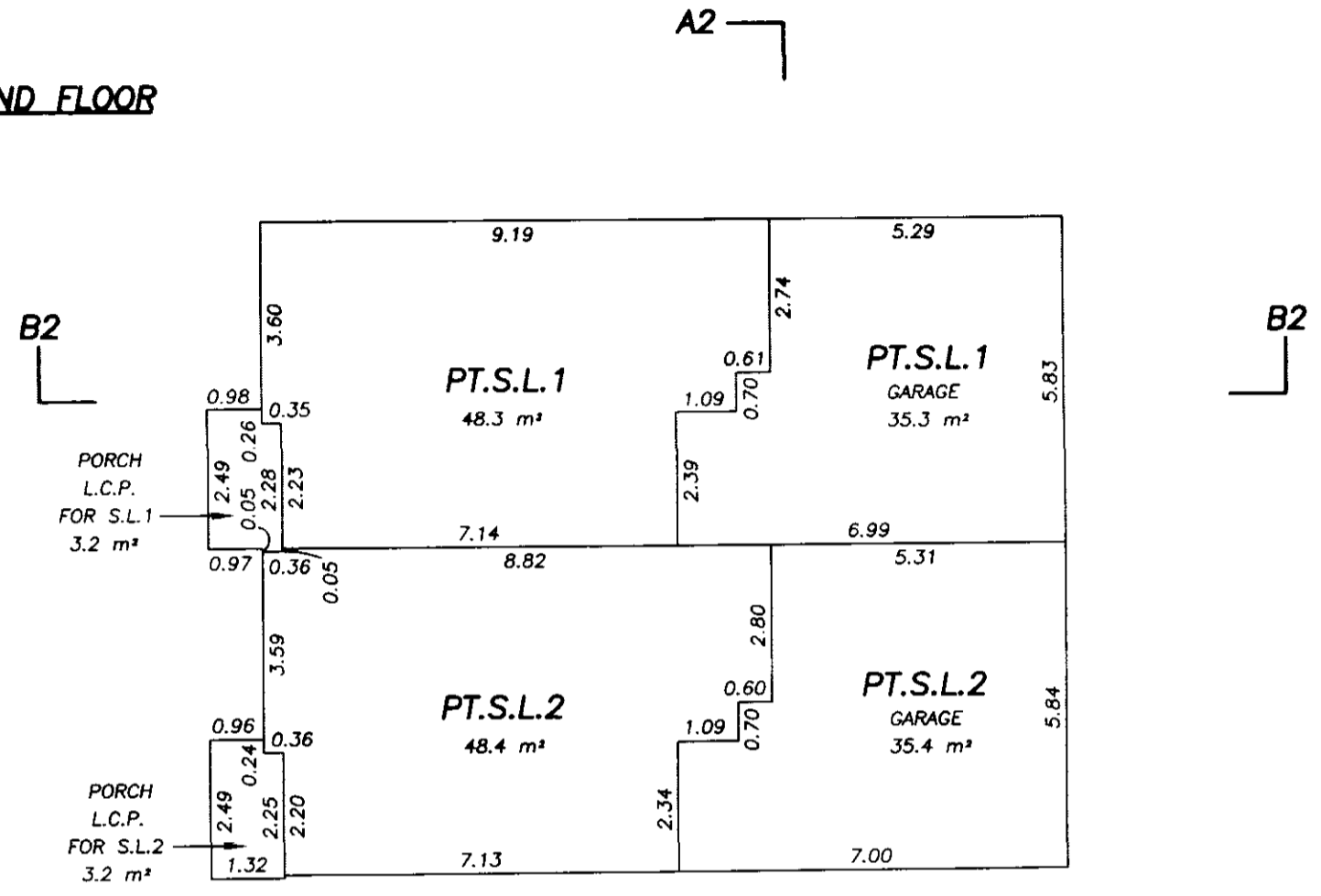

SECOND FLOOR

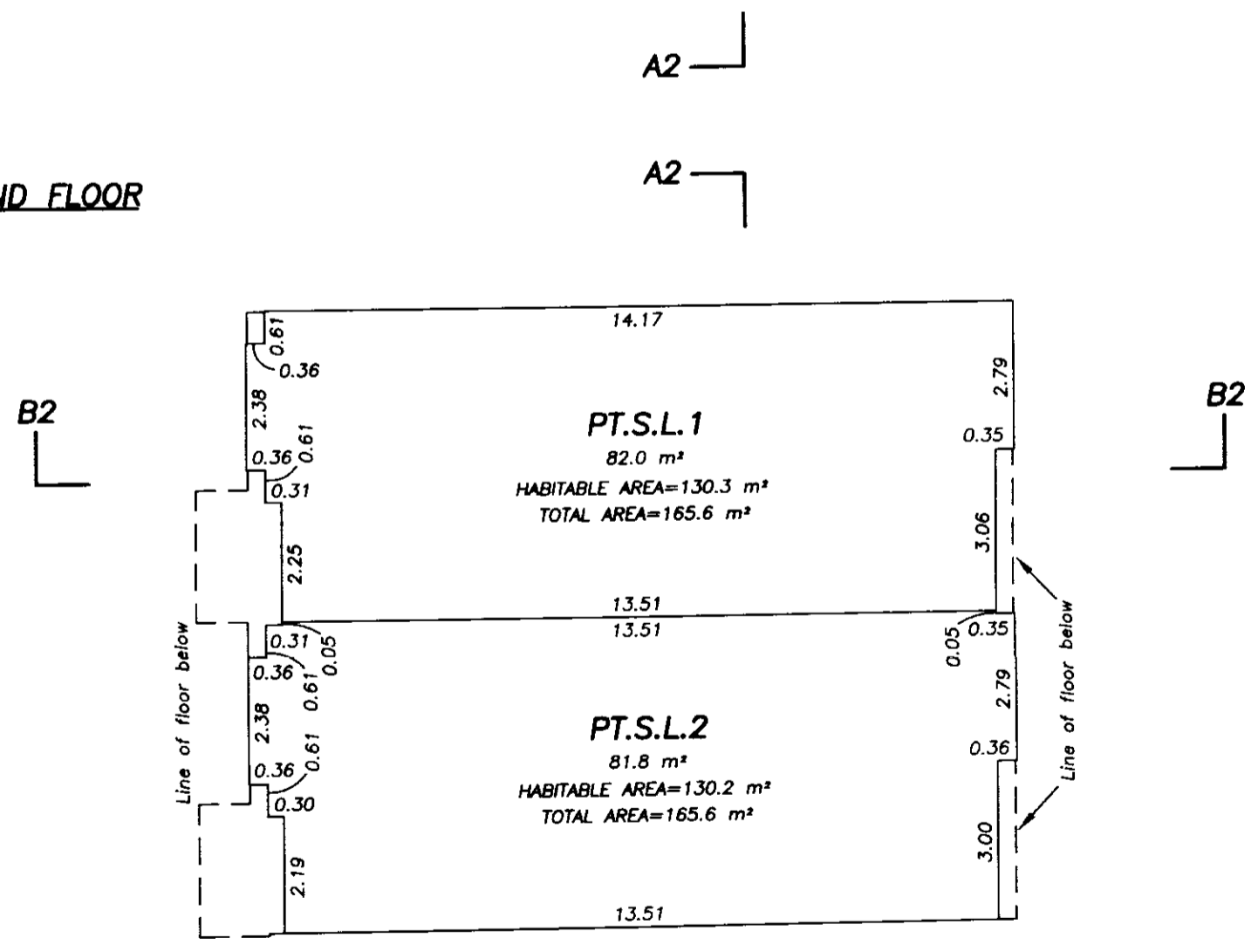

Johnson C. Tam
JOHNSON C. TAM, B.C.L.S.

August 18th, 2005.

FILED NWBCS1465 S33058 2005-12-02-12.01.35.196315

BUILDING 2 SECTIONS

STRATA PLAN BCS 1465

SCALE: 1:125

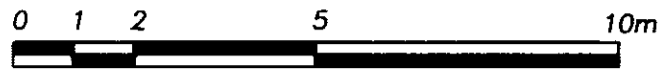

ALL DISTANCES ARE IN METRES AND DECIMALS THEREOF UNLESS OTHERWISE INDICATED

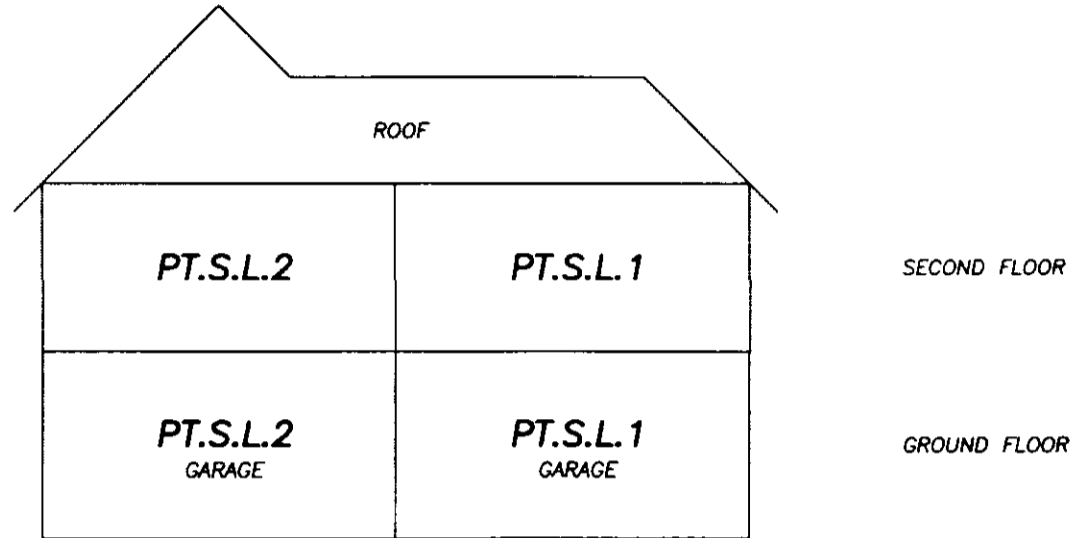

SECTION A2-A2

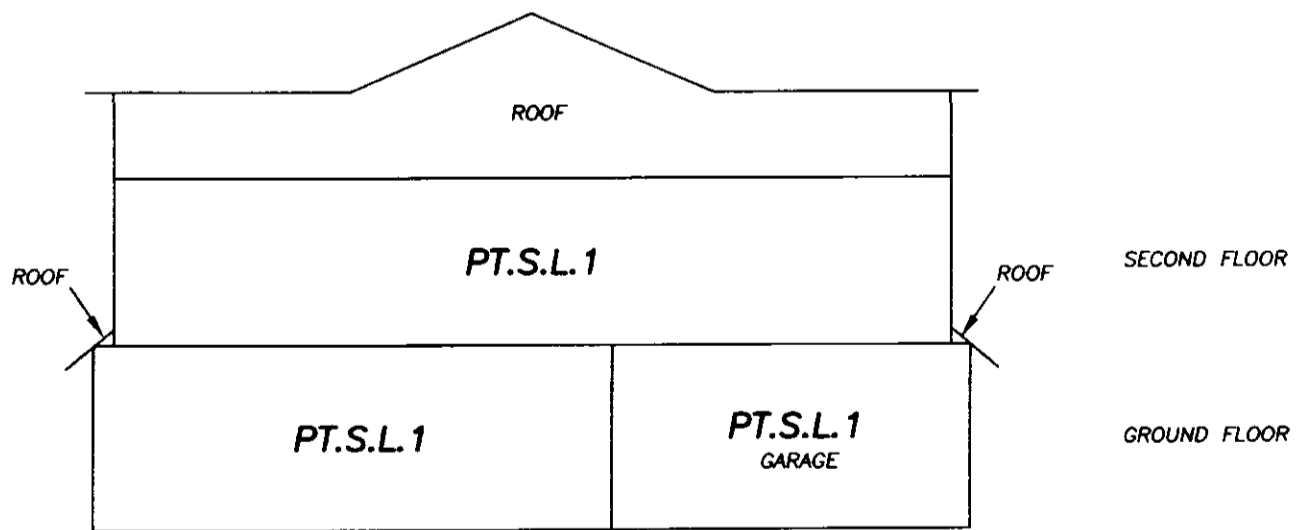

SECTION B2-B2

JOHNSON C. TAM, B.C.L.S.

August 18th, 2005.

FILED NWBCS1465 S33058 2005-12-02-12.01.35.196315

BUILDING 3
STRATA LOTS 3 AND 4

STRATA PLAN BCS 1465

SCALE: 1:125

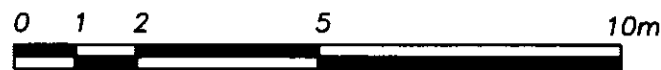

ALL DISTANCES ARE IN METRES AND DECIMALS THEREOF UNLESS OTHERWISE INDICATED

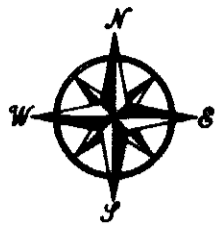

GROUND FLOOR

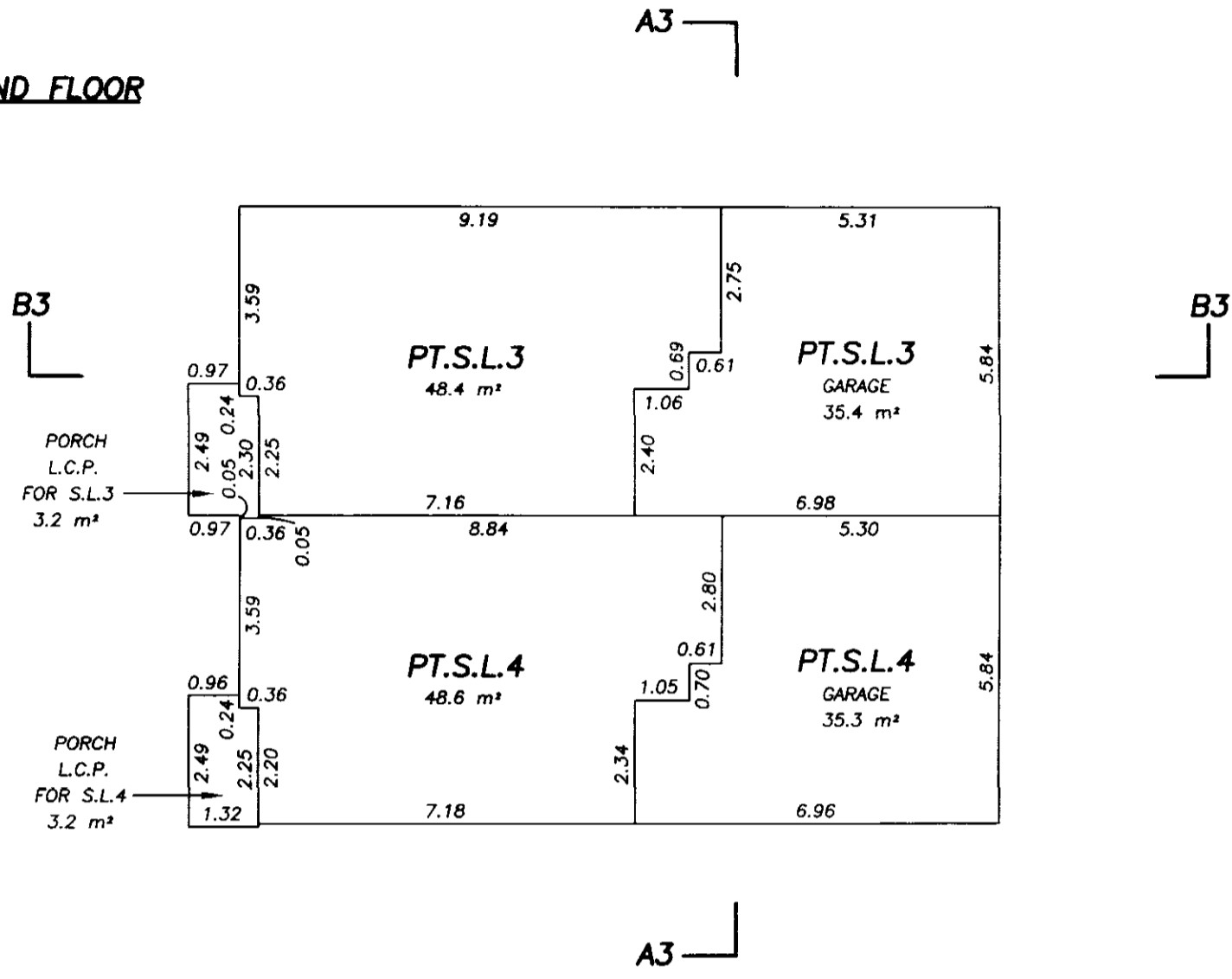

SECOND FLOOR

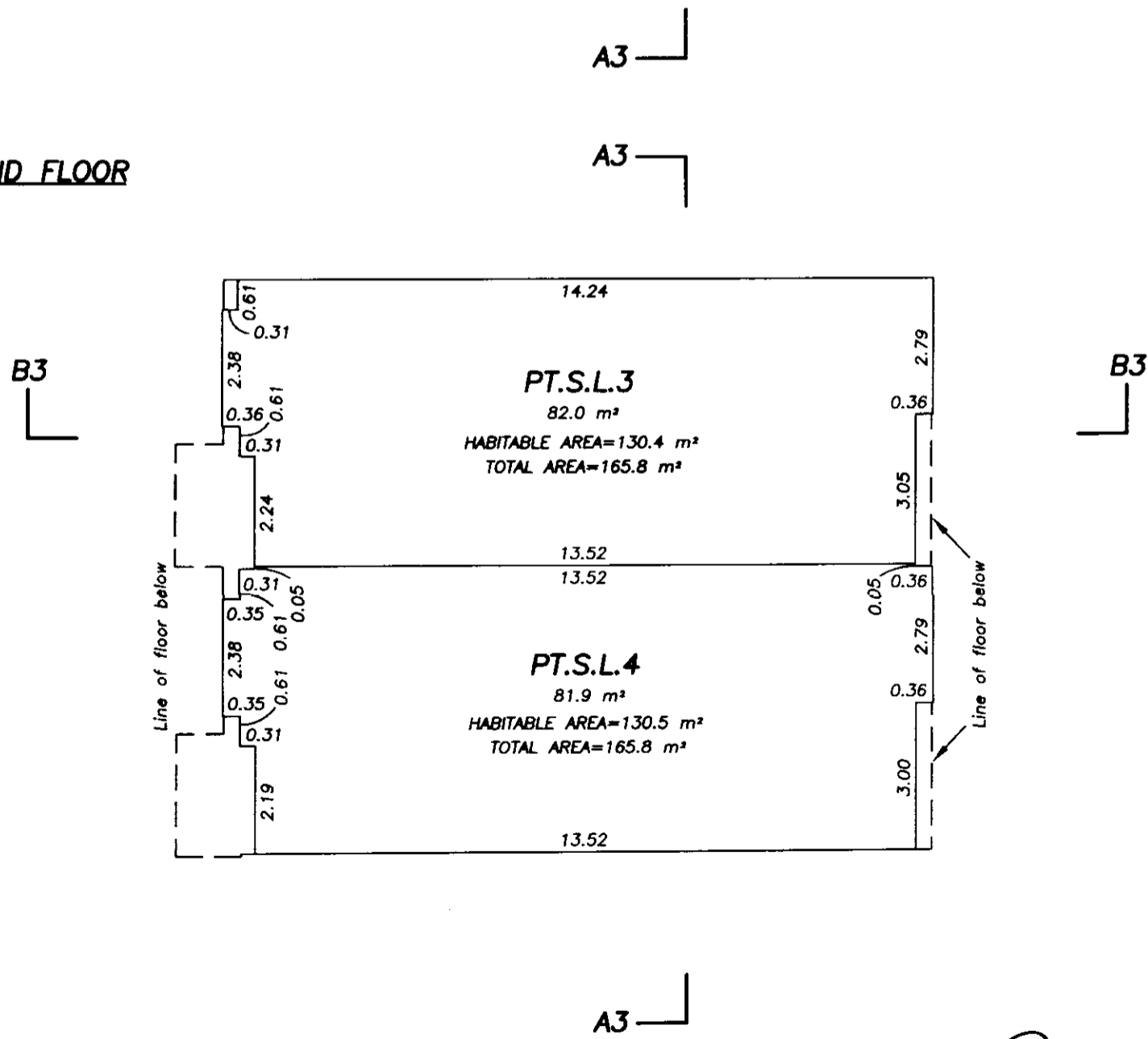

Johnson C. Tam
JOHNSON C. TAM, B.C.L.S.

August 18th, 2005.

FILED
NWBCS1465
S33058
2005-12-02-12.01.35.196315

BUILDING 3 SECTIONS

STRATA PLAN BCS 1465

SCALE: 1:125

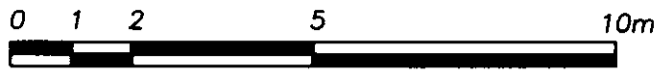

ALL DISTANCES ARE IN METRES AND DECIMALS THEREOF UNLESS OTHERWISE INDICATED

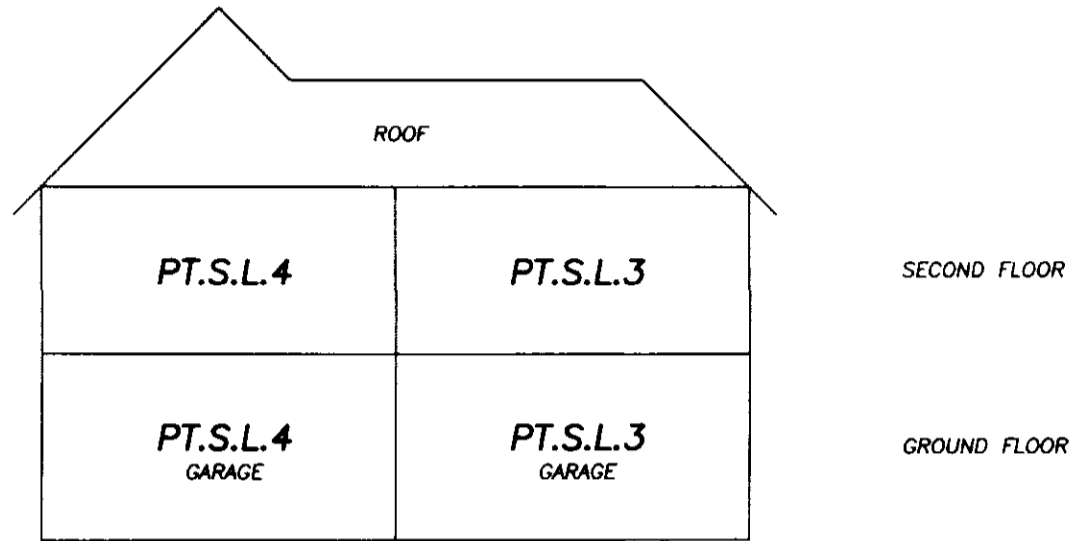

SECTION A3-A3

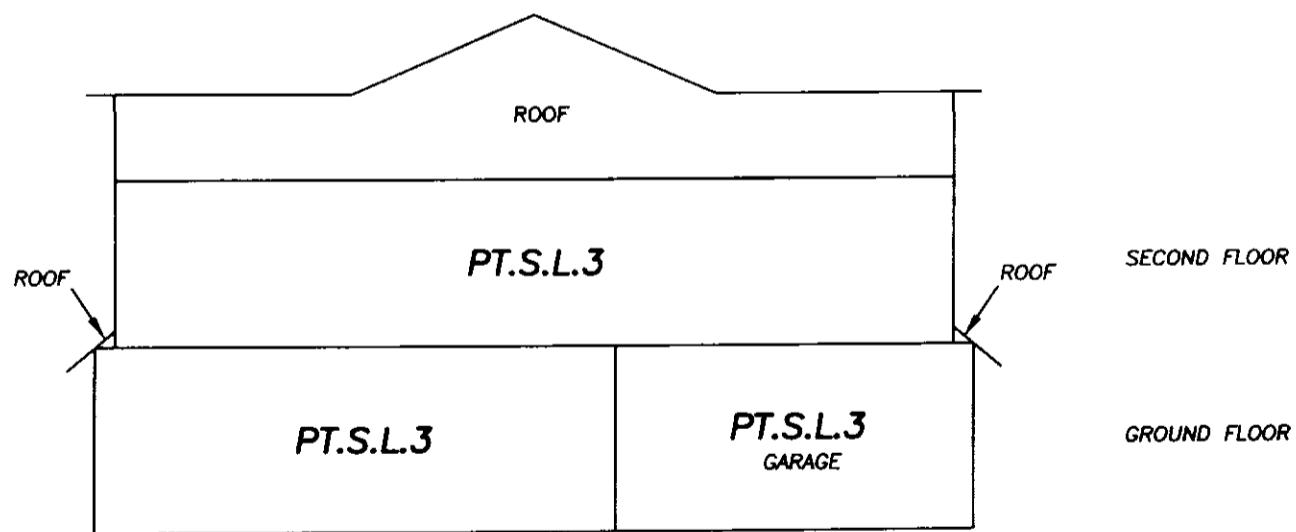

SECTION B3-B3

JOHNSON C. TAM, B.C.L.S.

August 18th, 2005.

FILED NWBCS1465 S33058 2005-12-02-12.01.35.196315

BUILDING 4
STRATA LOT 5

STRATA PLAN BCS 1465

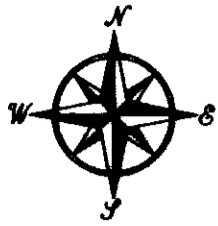

SCALE: 1:125

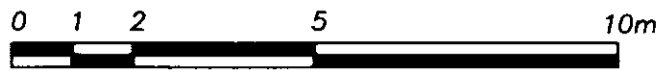

ALL DISTANCES ARE IN METRES AND DECIMALS
THEREOF UNLESS OTHERWISE INDICATED

GROUND FLOOR

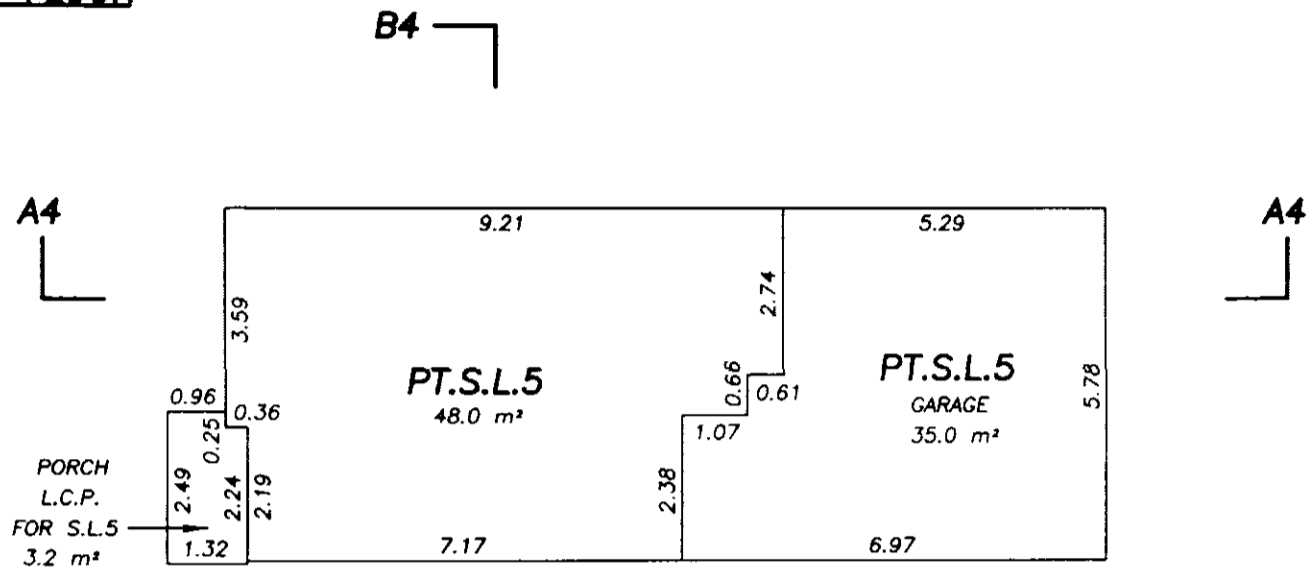

SECOND FLOOR

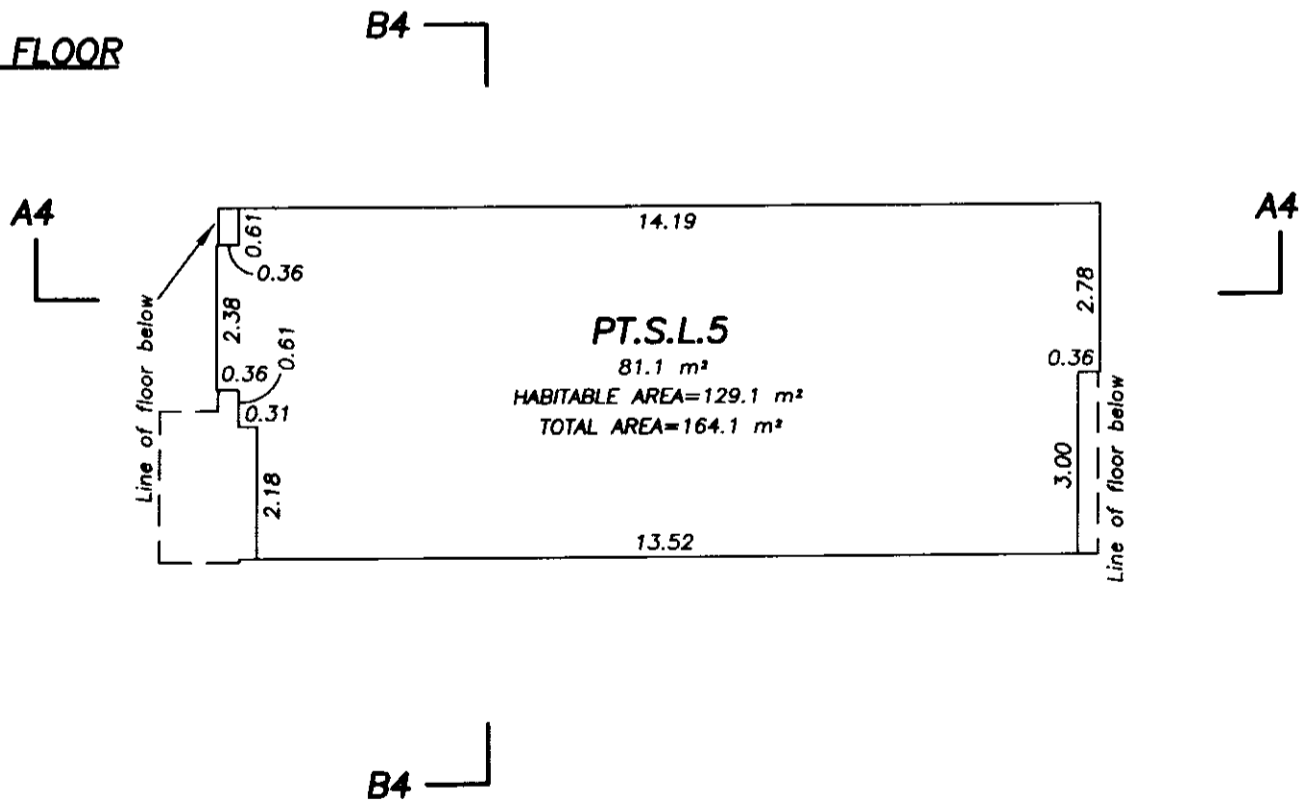

Johnson C. Tam
JOHNSON C. TAM, B.C.L.S.

August 18th, 2005.

FILED NWBCS1465 S33058 2005-12-02-12.01.35.196315

BUILDING 4 SECTIONS

STRATA PLAN BCS 1465

SCALE: 1:125

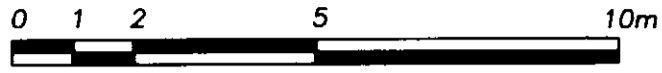

ALL DISTANCES ARE IN METRES AND DECIMALS THEREOF UNLESS OTHERWISE INDICATED

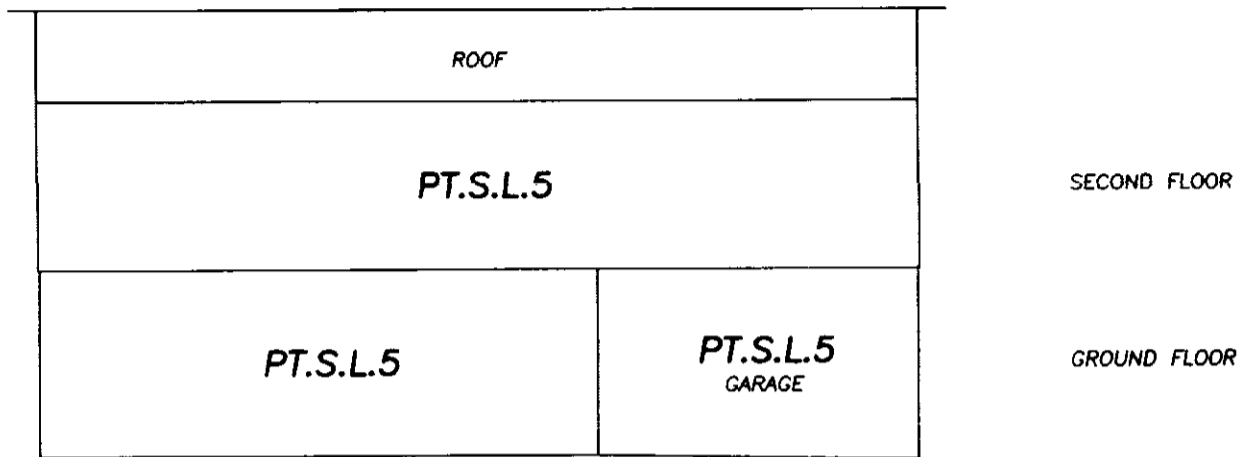

SECTION A4-A4

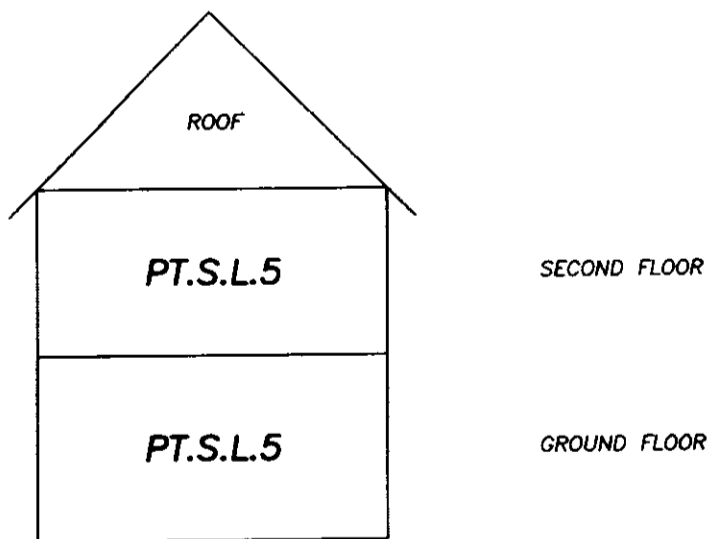

SECTION B4-B4

JOHNSON C. TAM, B.C.L.S.

August 18th, 2005.

BUILDING 5
STRATA LOTS 6 AND 7

STRATA PLAN BCS 1465

SCALE: 1:125



ALL DISTANCES ARE IN METRES AND DECIMALS THEREOF UNLESS OTHERWISE INDICATED

GROUND FLOOR

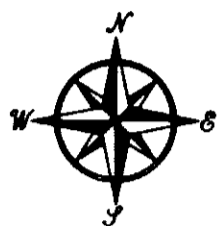

B5

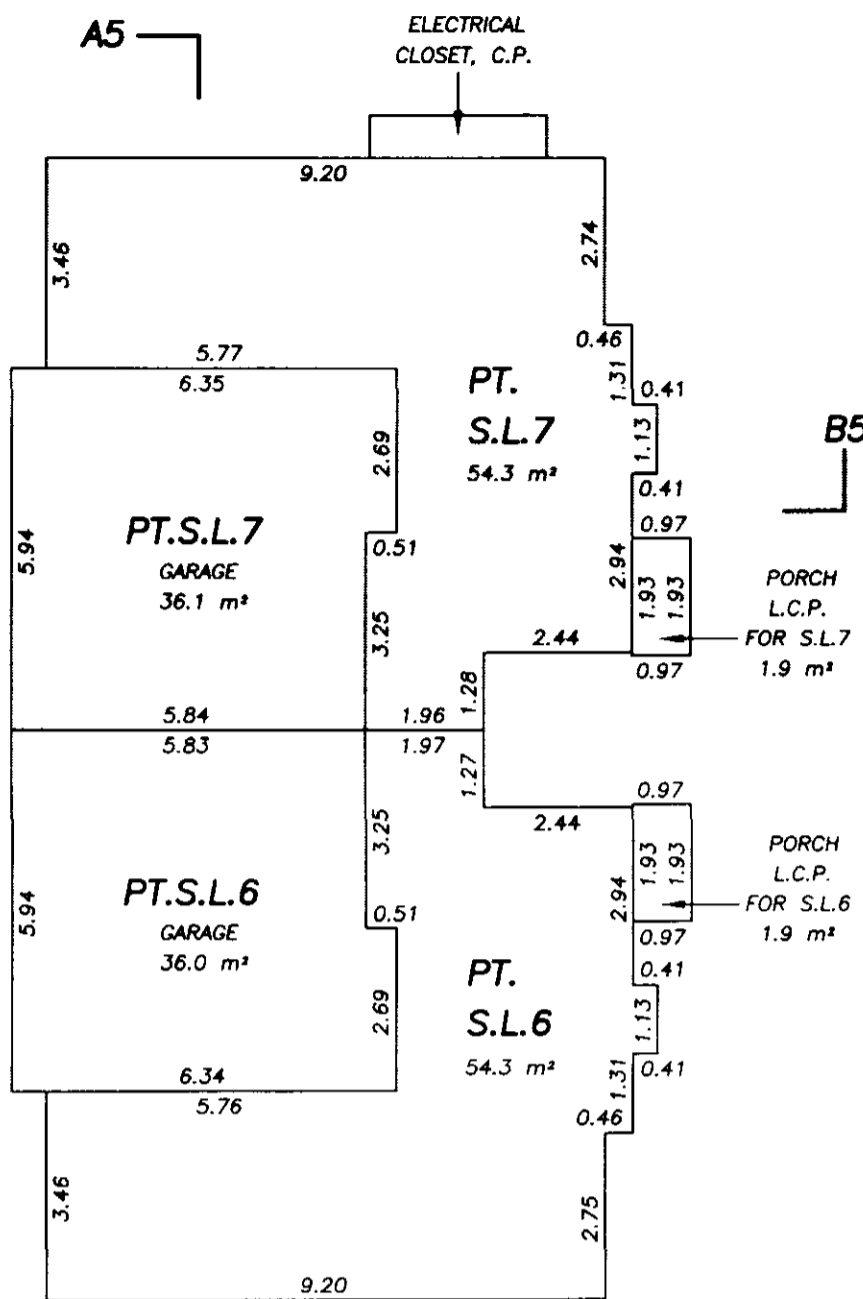

SECOND FLOOR

B5

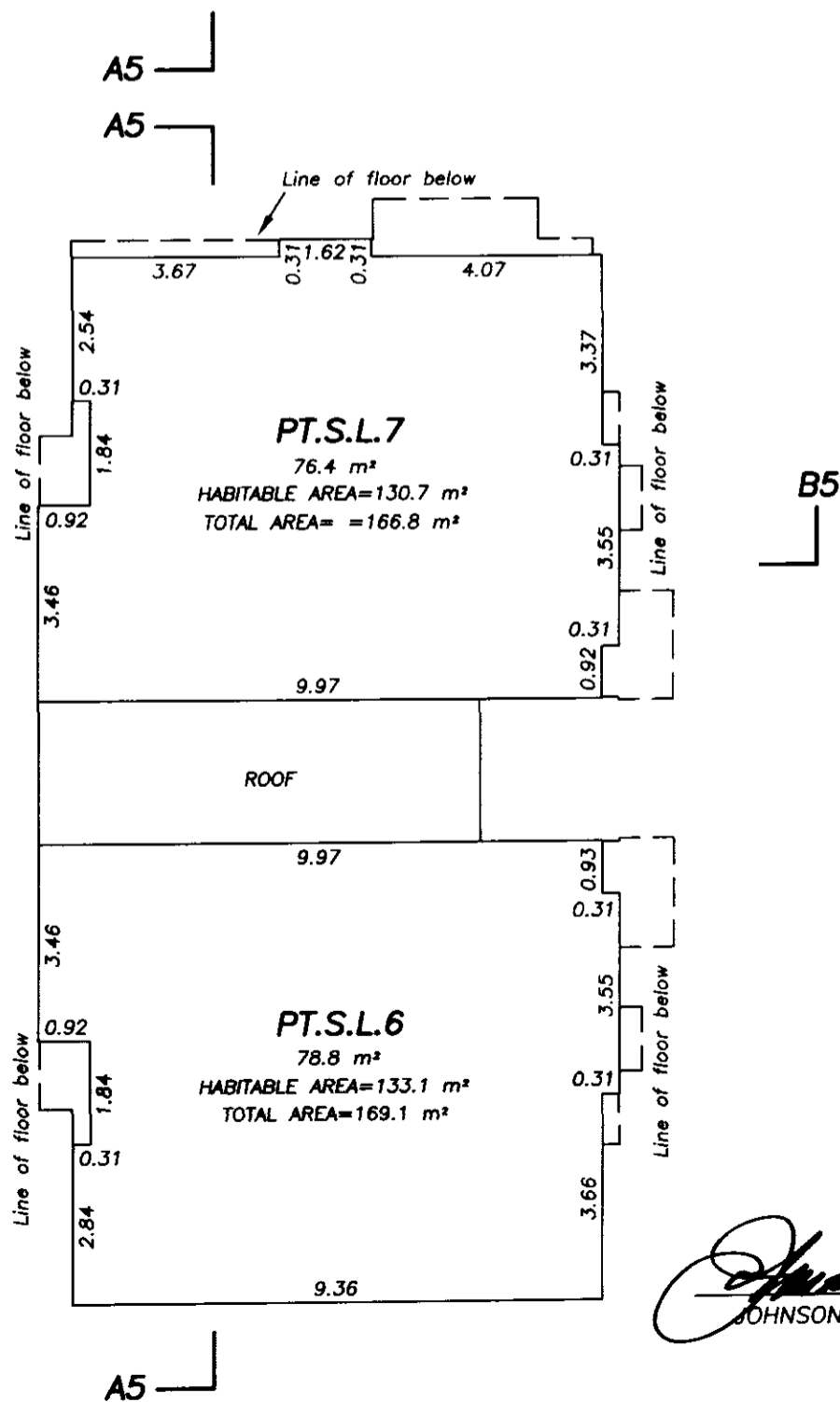

Johnson C. Tam
JOHNSON C. TAM, B.C.L.S.

August 18th, 2005.

BUILDING 5 SECTIONS

STRATA PLAN BCS 1465

SCALE: 1:125



ALL DISTANCES ARE IN METRES AND DECIMALS THEREOF UNLESS OTHERWISE INDICATED

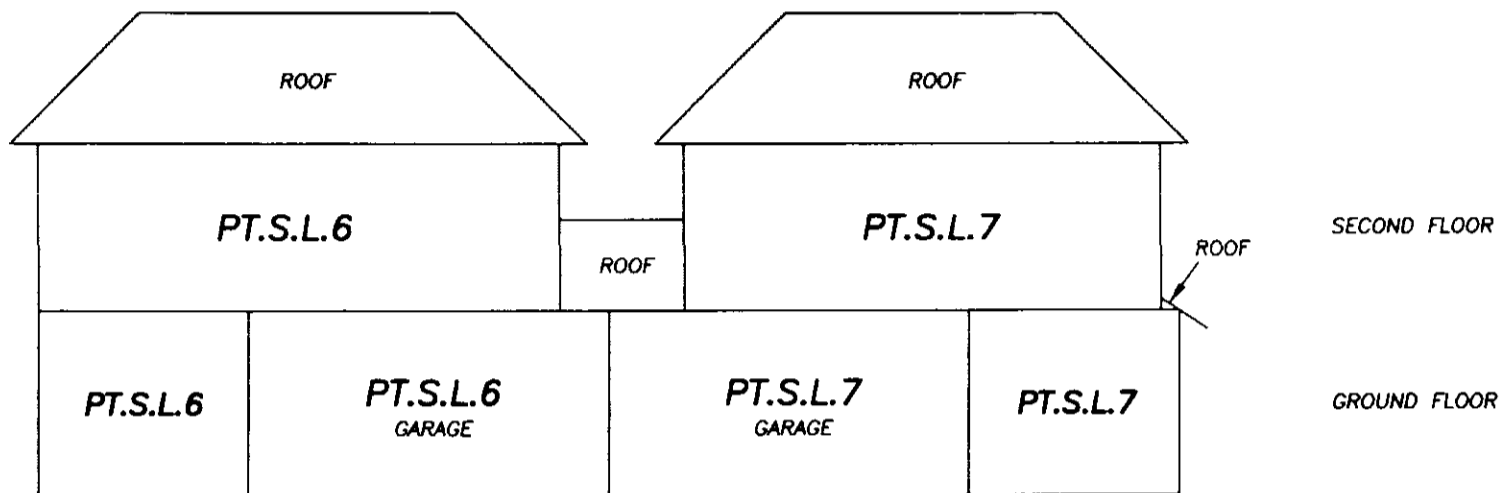

SECTION A5-A5

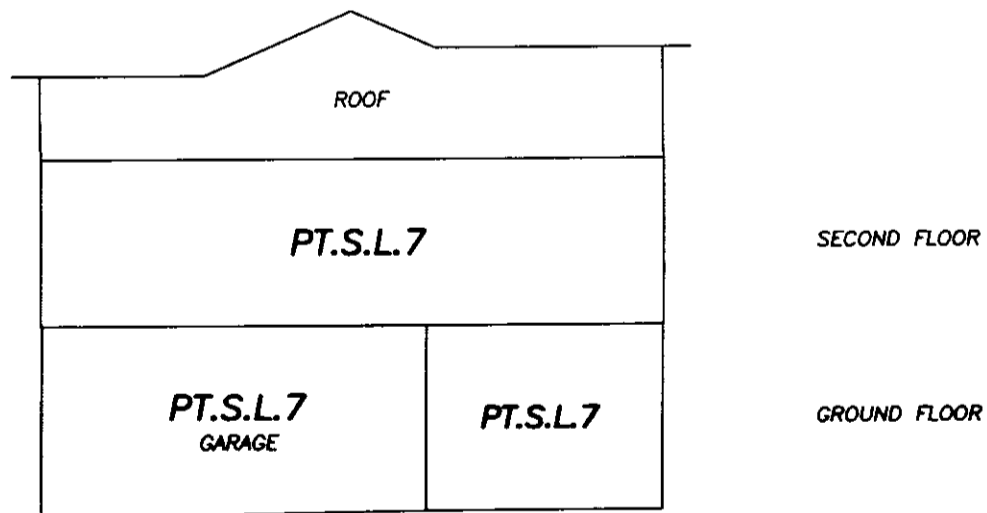

SECTION B5-B5

 JOHNSON C. TAM, B.C.L.S.

August 18th, 2005.

FILED
NWBCS1465
S33058
2005-12-02-12.01.35.196315

BUILDING 8
STRATA LOTS 8 AND 9

STRATA PLAN BCS 1465

SCALE: 1:125

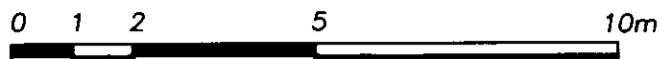

ALL DISTANCES ARE IN METRES AND DECIMALS
THEREOF UNLESS OTHERWISE INDICATED

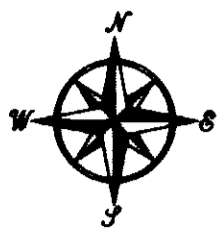

GROUND FLOOR

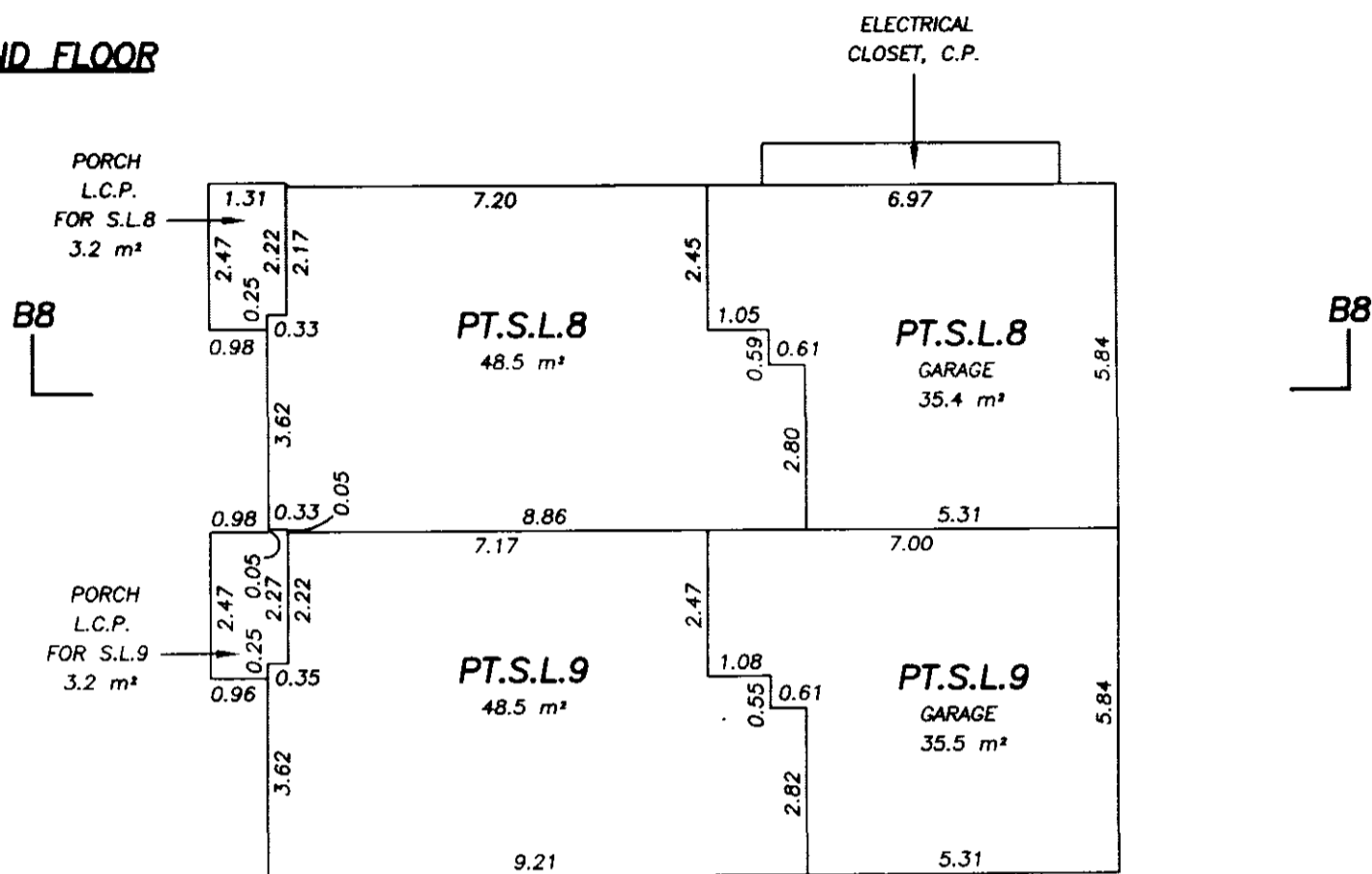

SECOND FLOOR

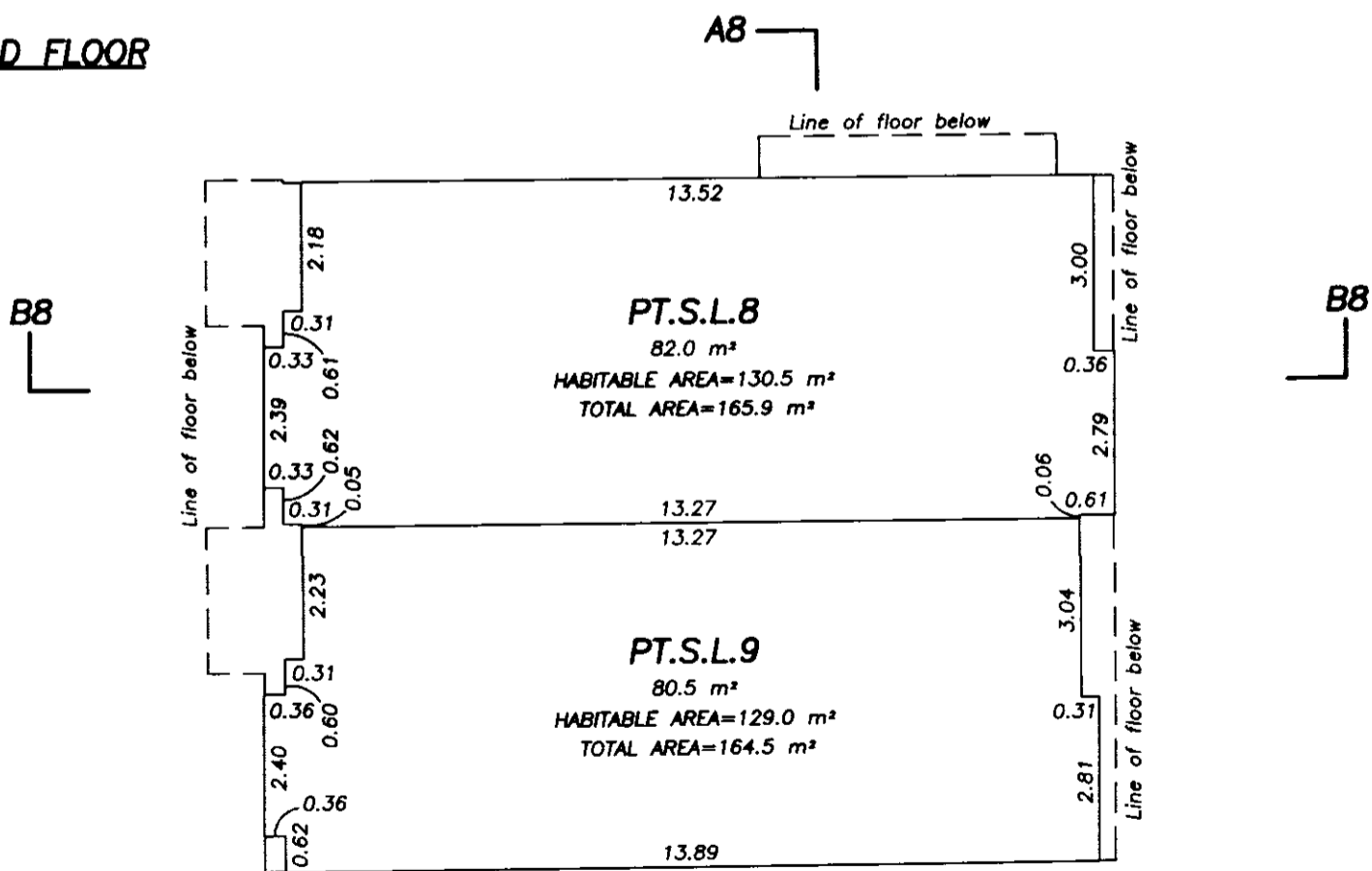

Johnson C. Tam
JOHNSON C. TAM, B.C.L.S.

August 18th, 2005.

BUILDING 8 SECTIONS

STRATA PLAN BCS 1465

SCALE: 1:125

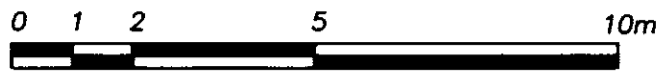

ALL DISTANCES ARE IN METRES AND DECIMALS THEREOF UNLESS OTHERWISE INDICATED

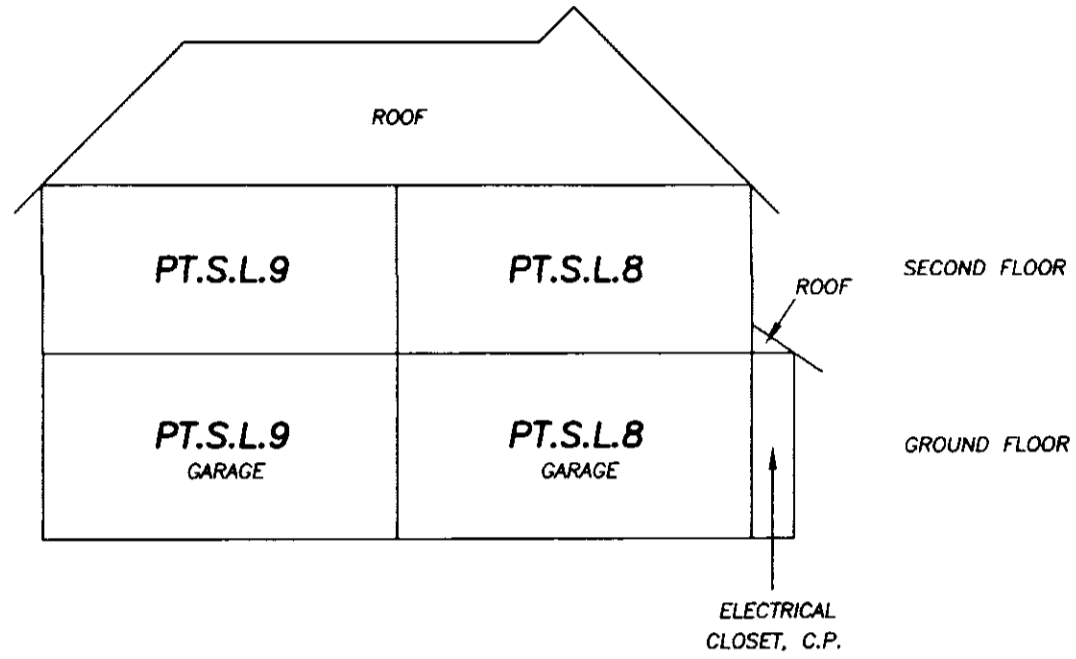

SECTION A8-A8

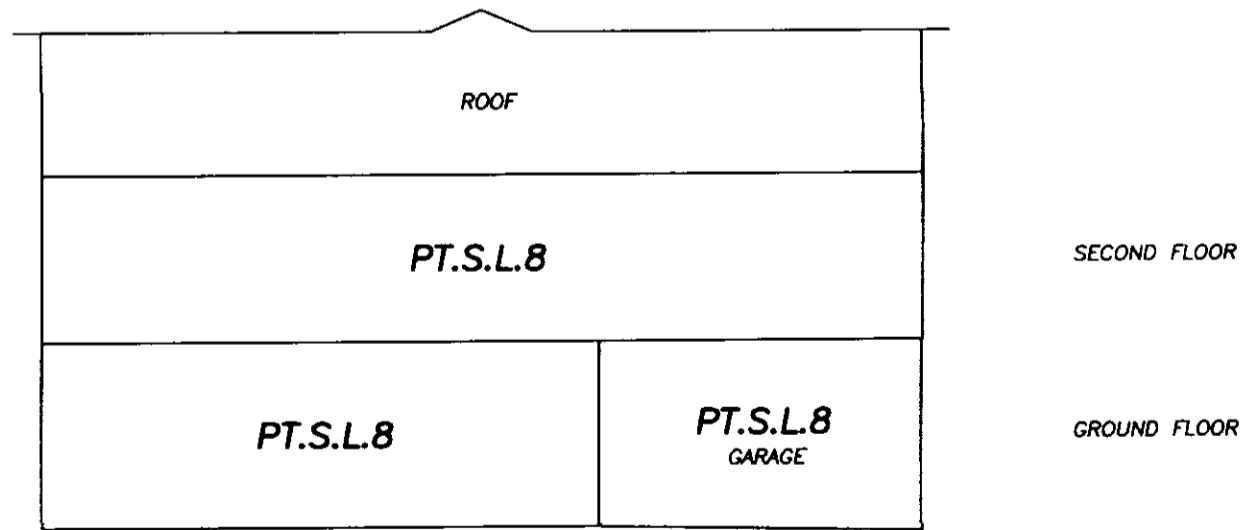

SECTION B8-B8



 JOHNSON C. TAM, B.C.L.S.

August 18th, 2005.

BUILDING 9
STRATA LOTS 10 AND 11

STRATA PLAN BCS 1465

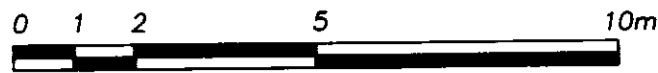
SCALE: 1:125



ALL DISTANCES ARE IN METRES AND DECIMALS THEREOF UNLESS OTHERWISE INDICATED



A9

GROUND FLOOR

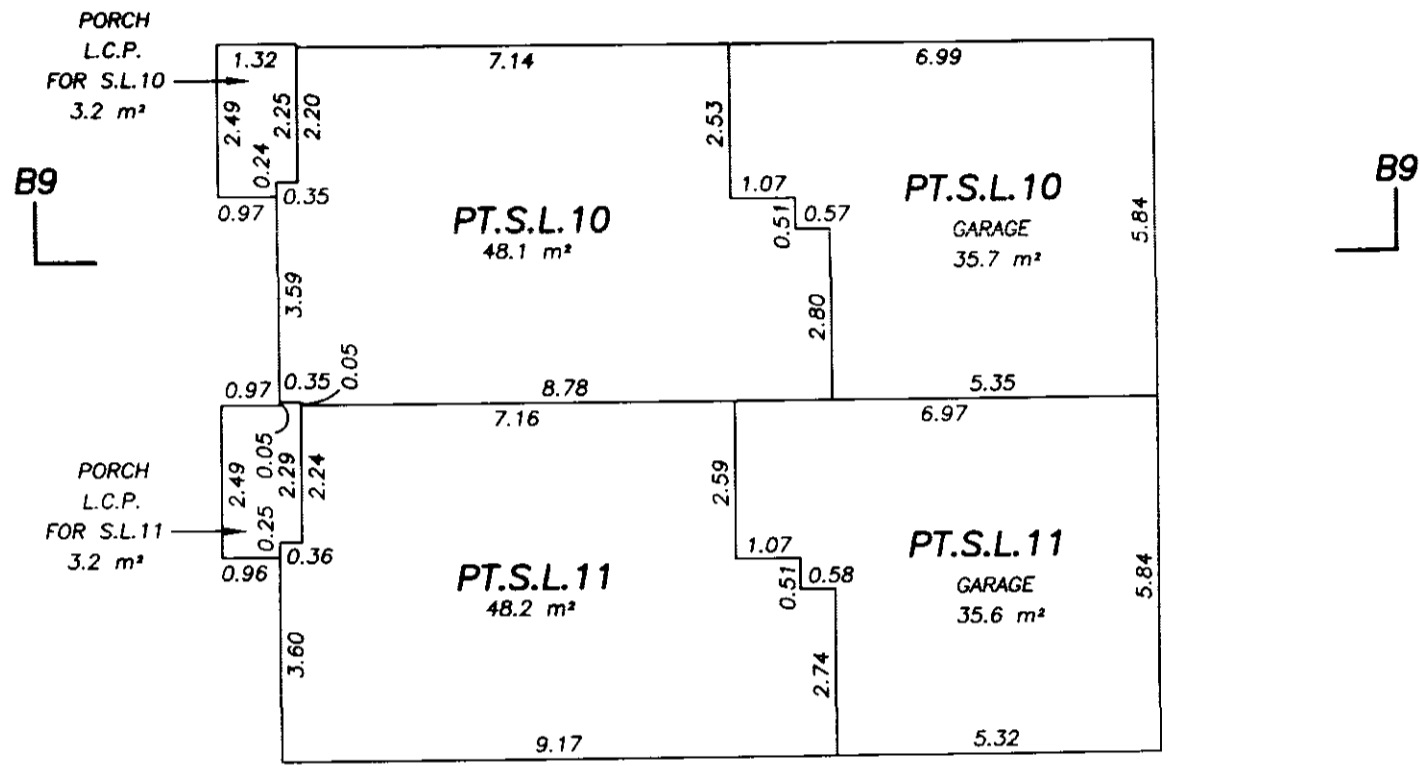

A9

A9

SECOND FLOOR

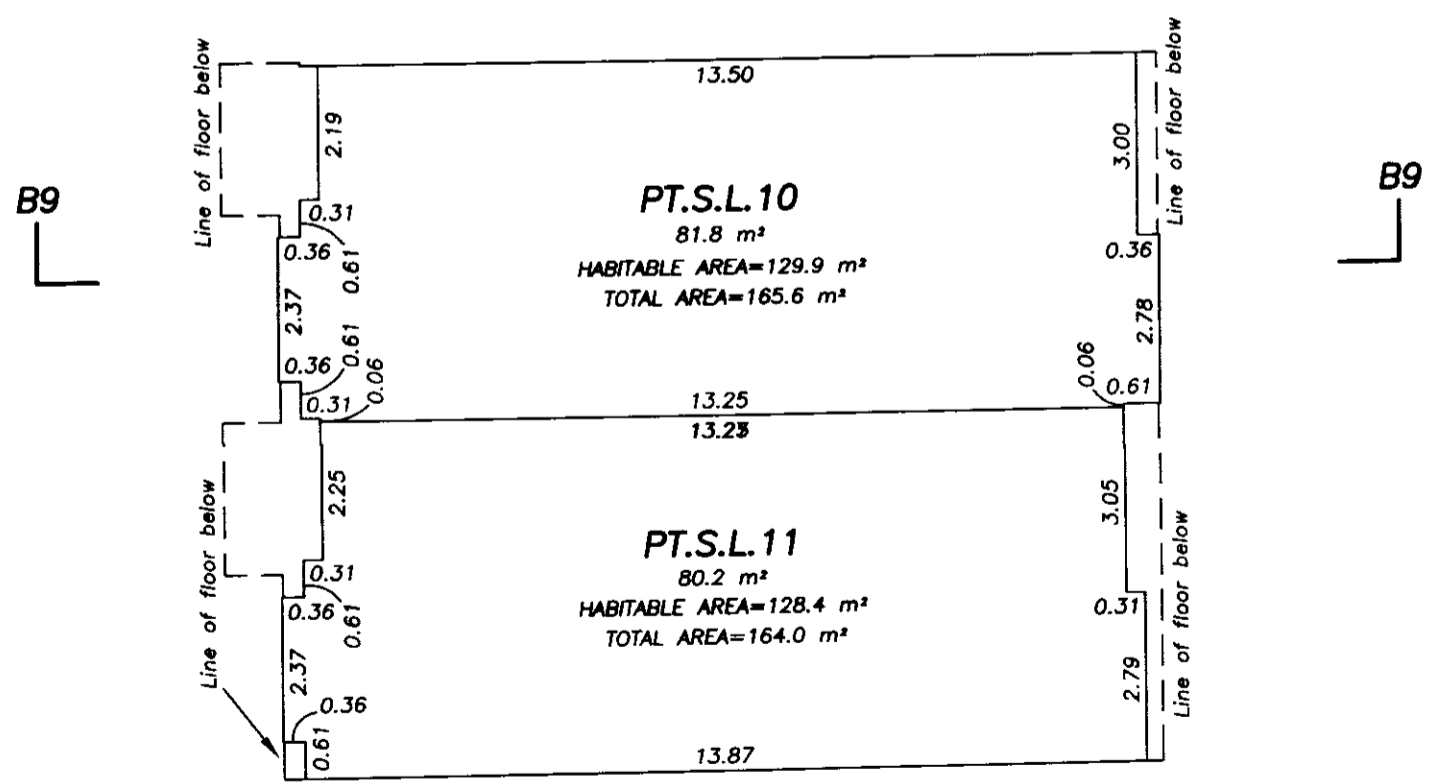

A9

Johnson C. Tam
JOHNSON C. TAM, B.C.L.S.

August 18th, 2005.

FILED NWBCS1465 2005-12-02-12.01.35.196315 S33058

BUILDING 9 SECTIONS

STRATA PLAN BCS 1465

SCALE: 1:125

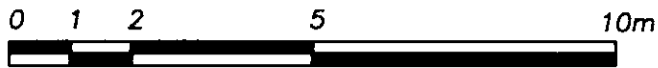

ALL DISTANCES ARE IN METRES AND DECIMALS THEREOF UNLESS OTHERWISE INDICATED

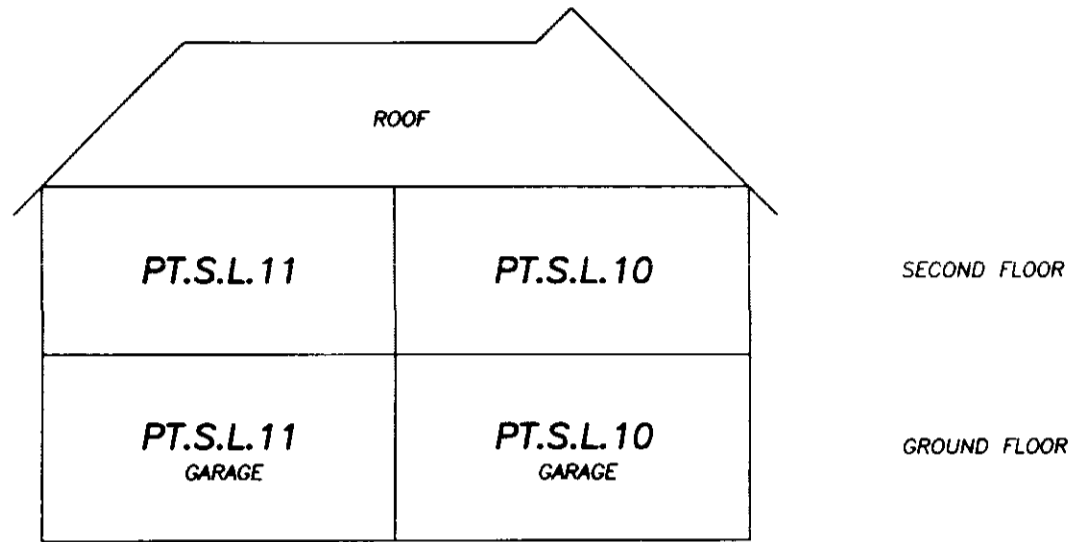

SECTION A9-A9

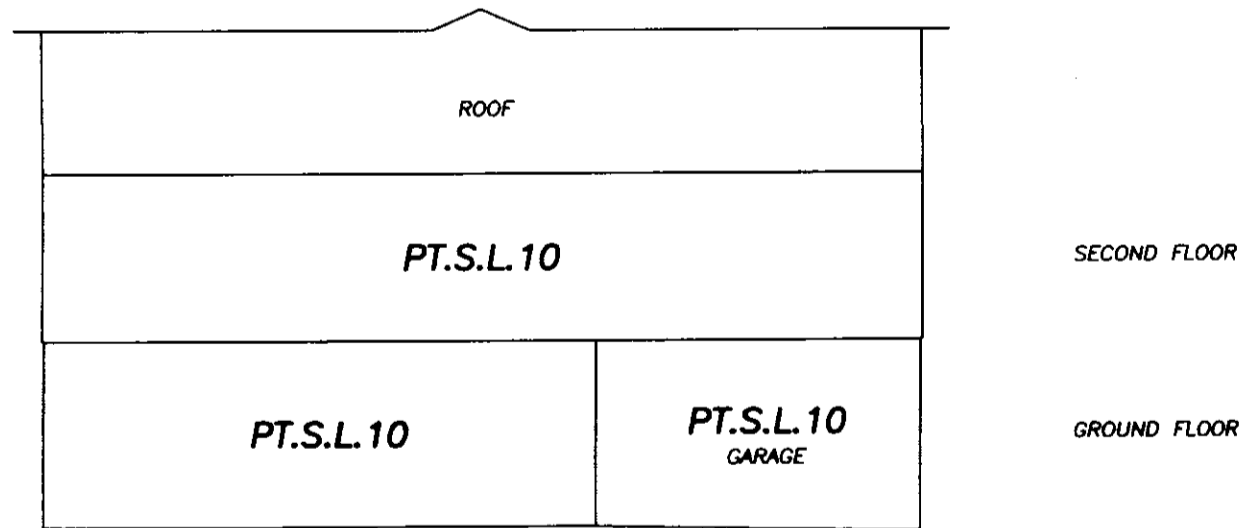

SECTION B9-B9

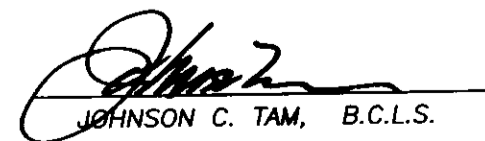
 JOHNSON C. TAM, B.C.L.S.

August 18th, 2005.

FILED NWBCS1465 S33058 2005-12-02-12.01.35.196315

BUILDING 10
STRATA LOT 12

STRATA PLAN BCS 1465

SCALE: 1:125

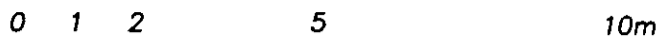

ALL DISTANCES ARE IN METRES AND DECIMALS
THEREOF UNLESS OTHERWISE INDICATED

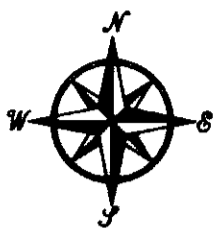

GROUND FLOOR

B10

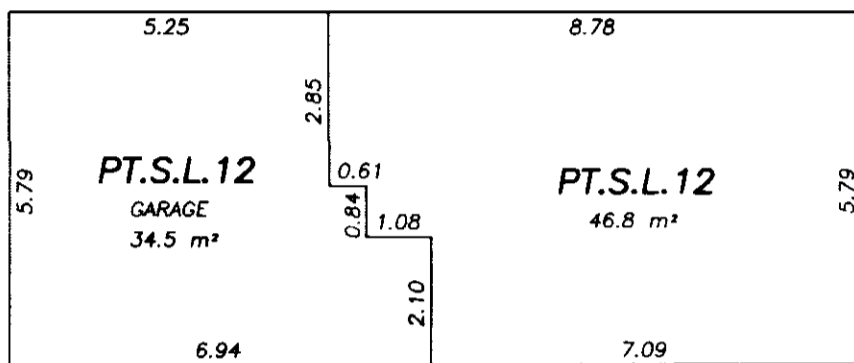

B10

A10

A10

A10

SECOND FLOOR

B10

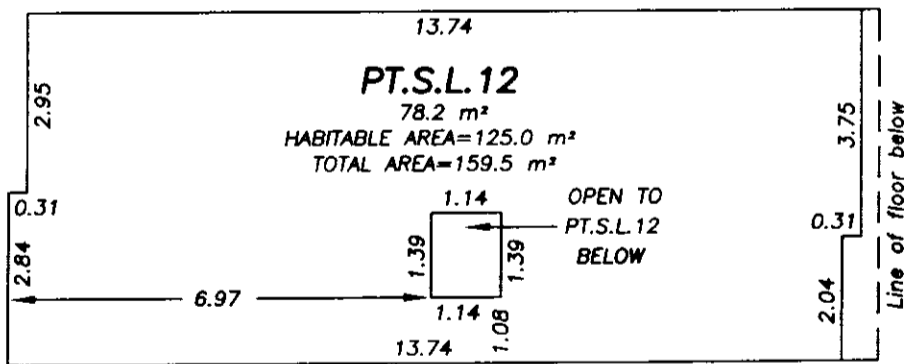

B10

A10

Johnson C. Tam
JOHNSON C. TAM, B.C.L.S.

August 18th, 2005.

BUILDING 10 SECTIONS

STRATA PLAN BCS 1465

SCALE: 1:125

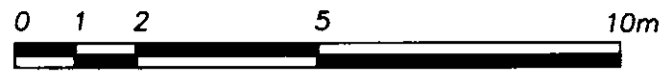

ALL DISTANCES ARE IN METRES AND DECIMALS THEREOF UNLESS OTHERWISE INDICATED

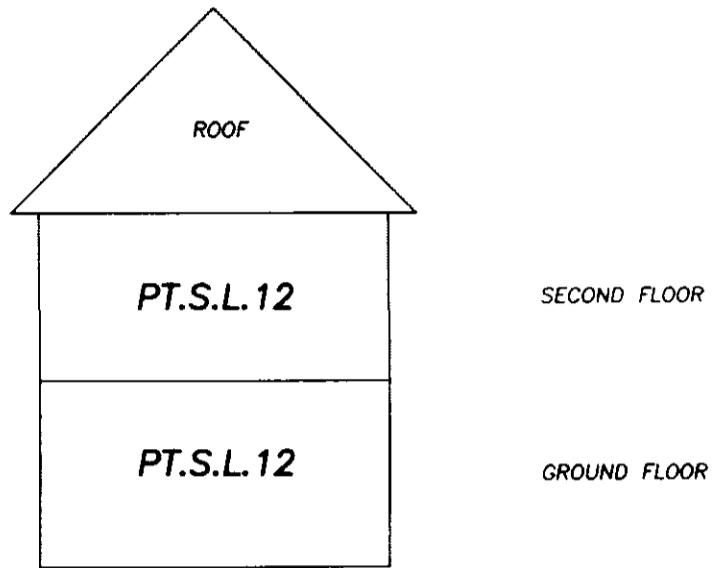

SECTION A10-A10

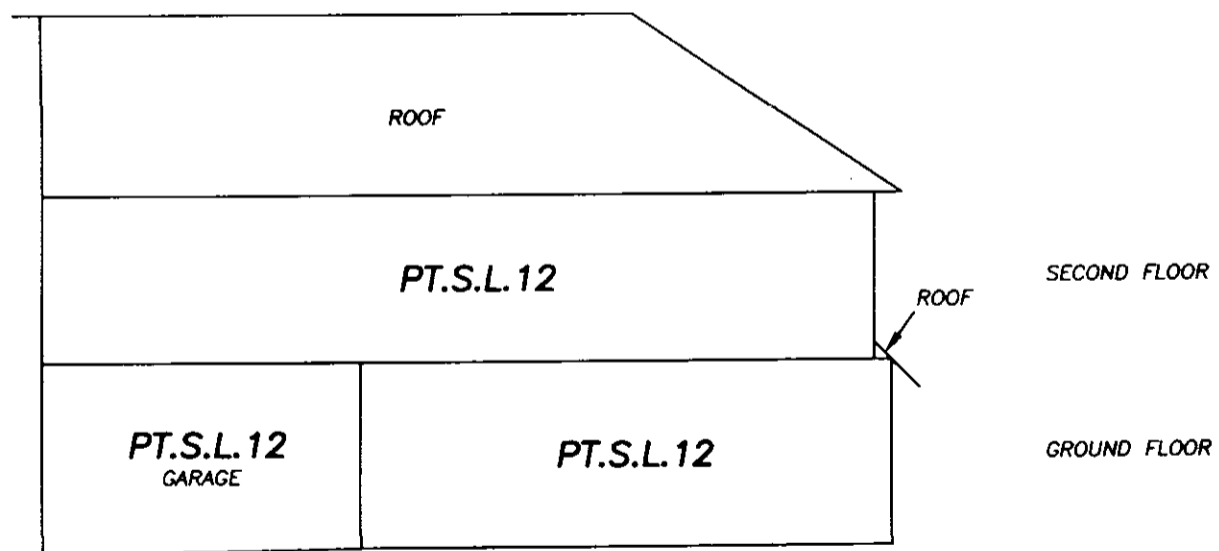

SECTION B10-B10

JOHNSON C. TAM, B.C.L.S.

August 18th, 2005.

FILED NWBCS1465 2005-12-02-12.01.35.196315 S33058

BUILDING 11
STRATA LOTS 13 AND 14

STRATA PLAN BCS 1465

SCALE: 1:125

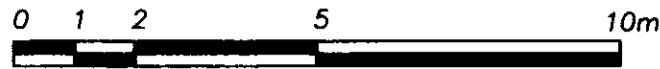

ALL DISTANCES ARE IN METRES AND DECIMALS
THEREOF UNLESS OTHERWISE INDICATED

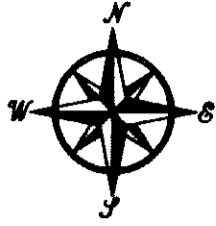

GROUND FLOOR

B11

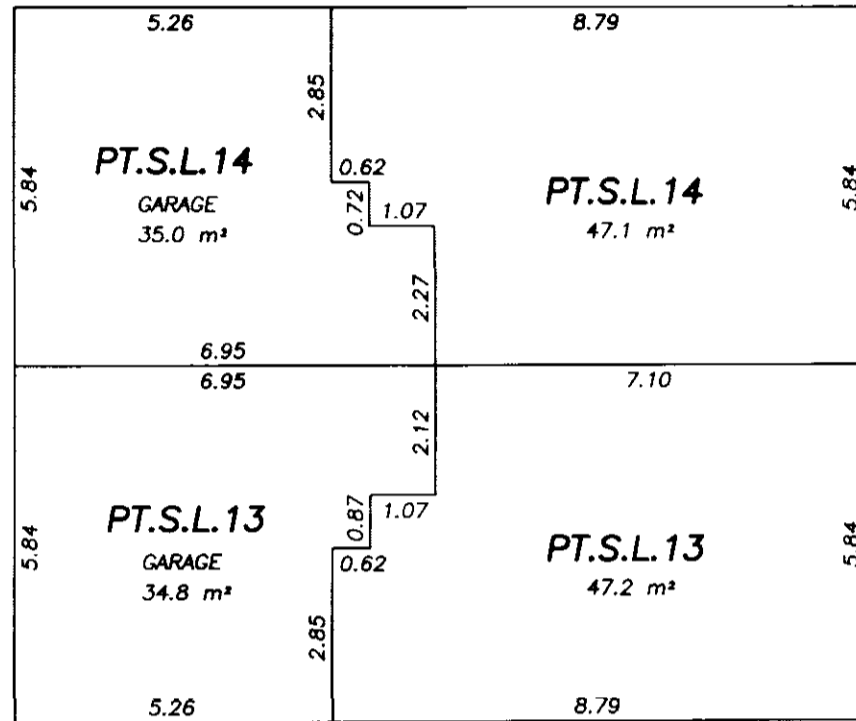

B11

A11

A11

SECOND FLOOR

B11

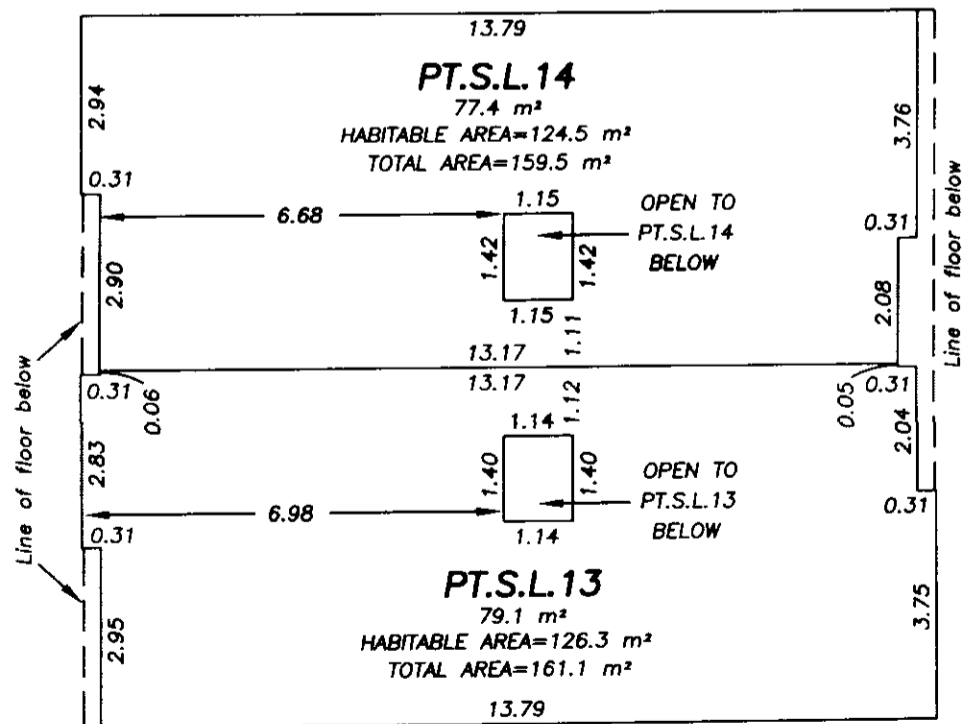

B11

A11

Johnson C. Tam
JOHNSON C. TAM, B.C.L.S.

August 18th, 2005.

BUILDING 11 SECTIONS

STRATA PLAN BCS 1465

SCALE: 1:125

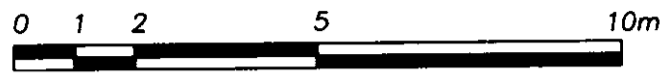

ALL DISTANCES ARE IN METRES AND DECIMALS THEREOF UNLESS OTHERWISE INDICATED

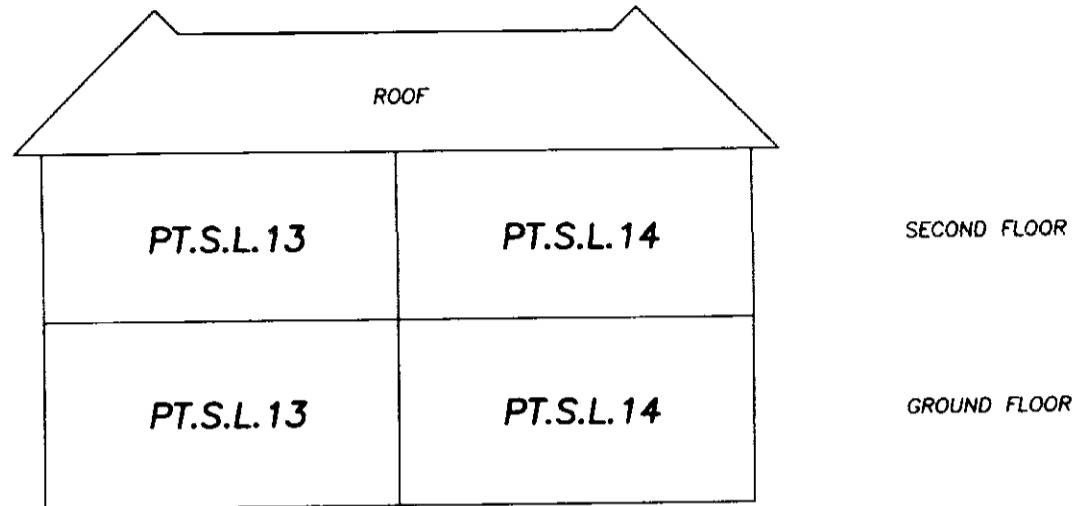

SECTION A11-A11

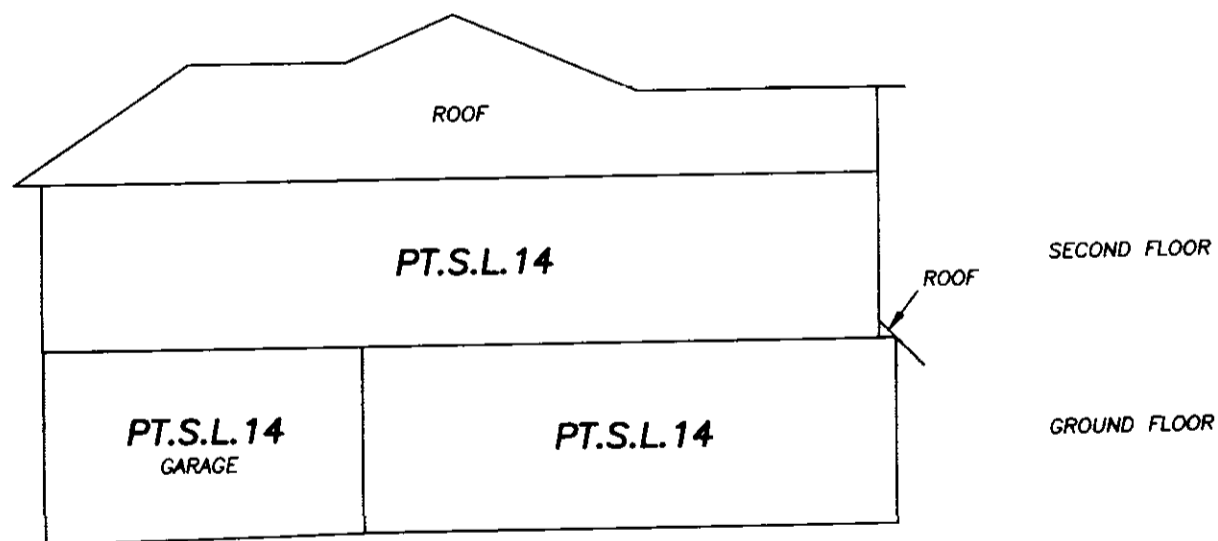

SECTION B11-B11

JOHNSON C. TAM, B.C.L.S.

August 18th, 2005.

FILED NWBCS1465 S33058 2005-12-02-12.01.35.196315

BUILDING 12
STRATA LOTS 15 AND 16

STRATA PLAN BCS 1465

SCALE: 1:125

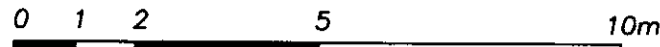

ALL DISTANCES ARE IN METRES AND DECIMALS
THEREOF UNLESS OTHERWISE INDICATED

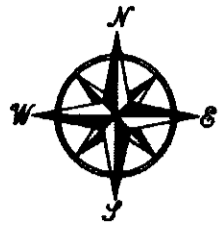

GROUND FLOOR

B12

A12

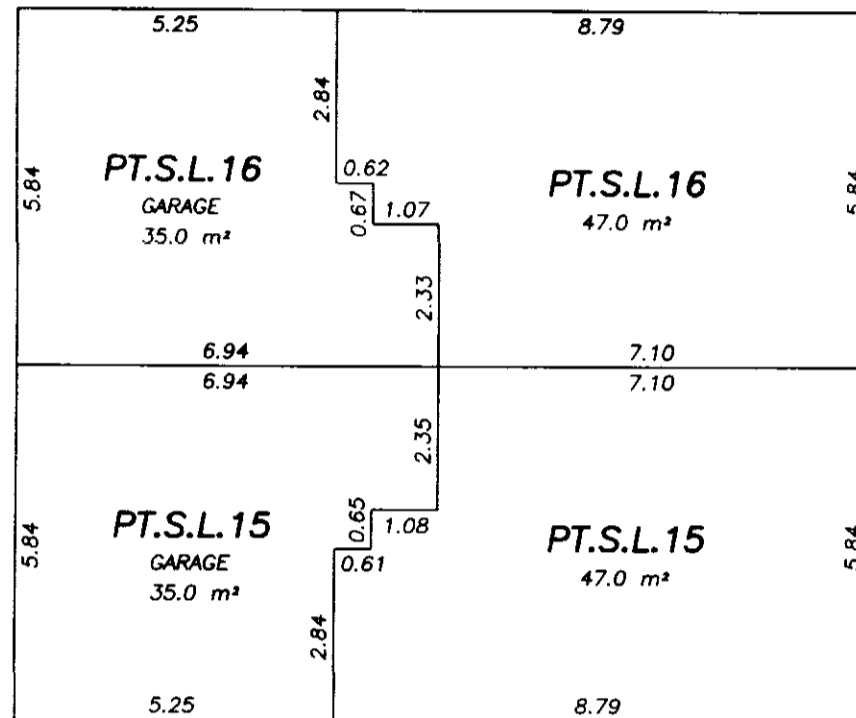

B12

SECOND FLOOR

B12

A12

A12

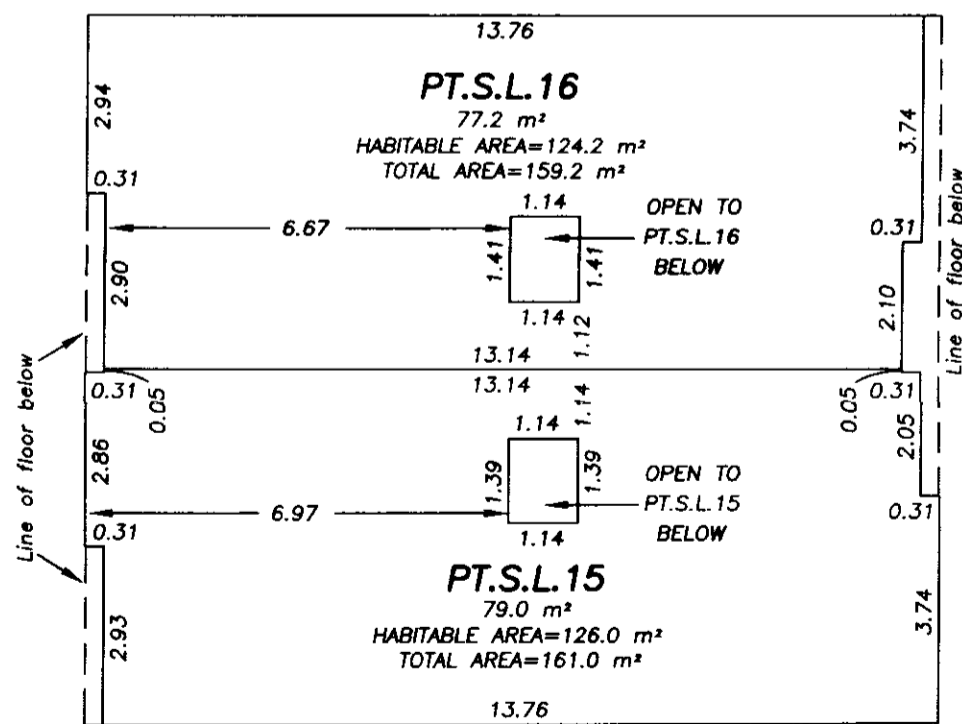

B12

A12

Johnson C. Tam
JOHNSON C. TAM, B.C.L.S.

August 18th, 2005.

FILED
NWBCS1465
S33058
2005-12-02-12.01.35.196315

BUILDING 12 SECTIONS

STRATA PLAN BCS 1465

SCALE: 1:125

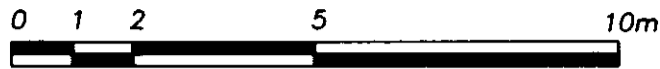

ALL DISTANCES ARE IN METRES AND DECIMALS THEREOF UNLESS OTHERWISE INDICATED

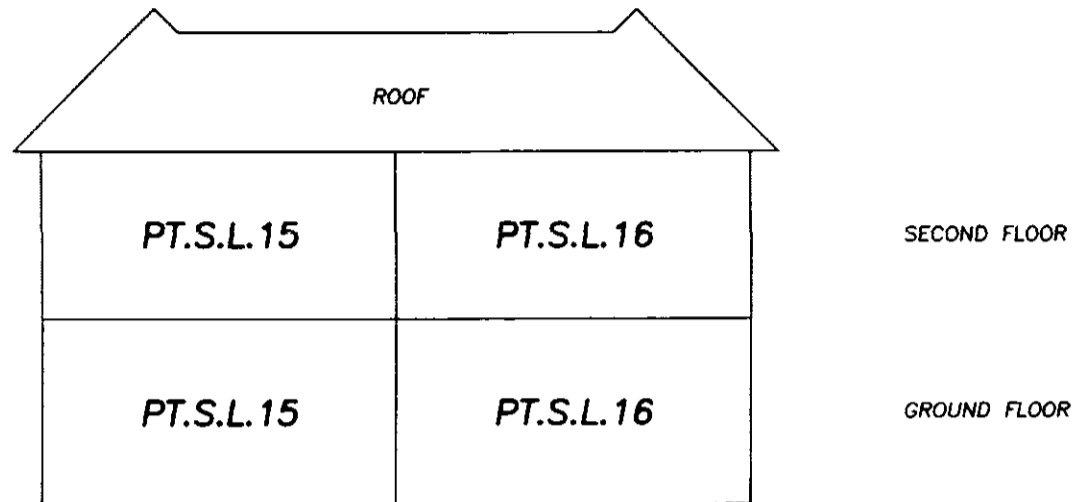

SECTION A12-A12

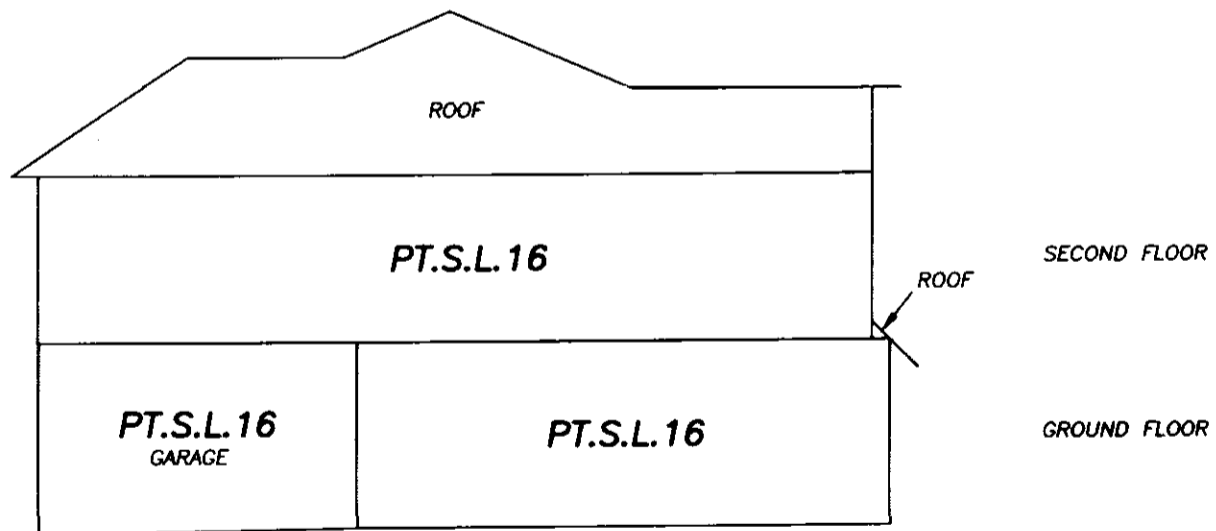

SECTION B12-B12

JOHNSON C. TAM, B.C.L.S.

August 18th, 2005.

FILED
NWBCS1465
S33058
2005-12-02-12.01.35.196315

BUILDING 13
STRATA LOTS 17 AND 18

STRATA PLAN BCS 1465

SCALE: 1:125



ALL DISTANCES ARE IN METRES AND DECIMALS
THEREOF UNLESS OTHERWISE INDICATED

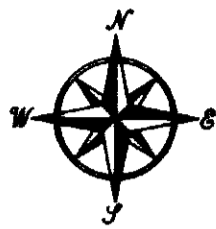

GROUND FLOOR

B13

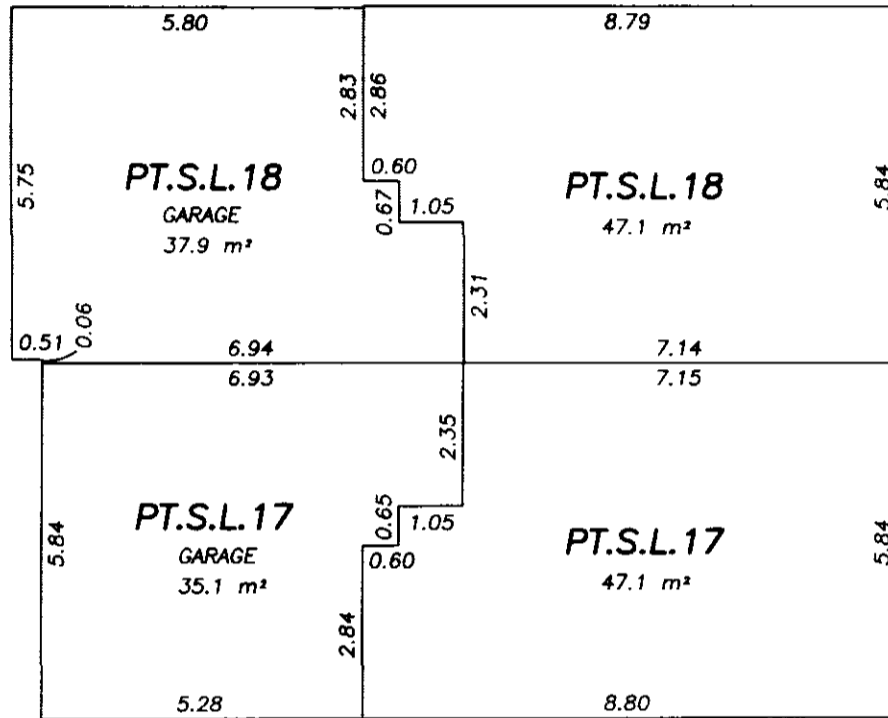

SECOND FLOOR

B13

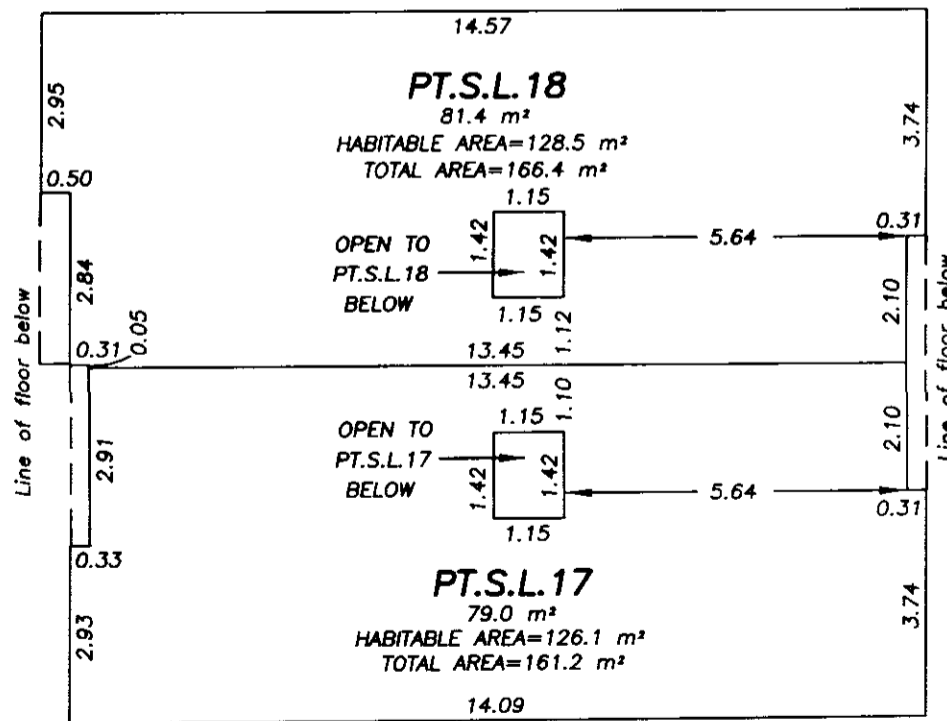

Johnson C. Tam
JOHNSON C. TAM, B.C.L.S.

August 18th, 2005.

FILED
NWBCS1465
S33058
2005-12-02-12.01.35.196315

BUILDING 13 SECTIONS

STRATA PLAN BCS 1465

SCALE: 1:125

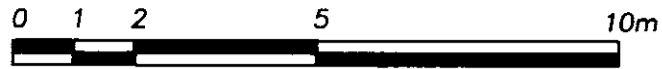

ALL DISTANCES ARE IN METRES AND DECIMALS THEREOF UNLESS OTHERWISE INDICATED

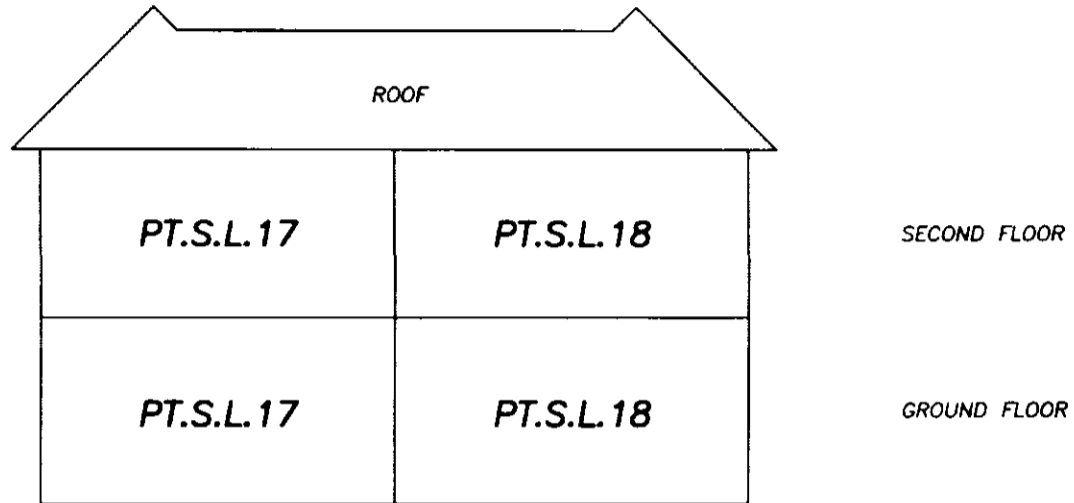

SECTION A13-A13

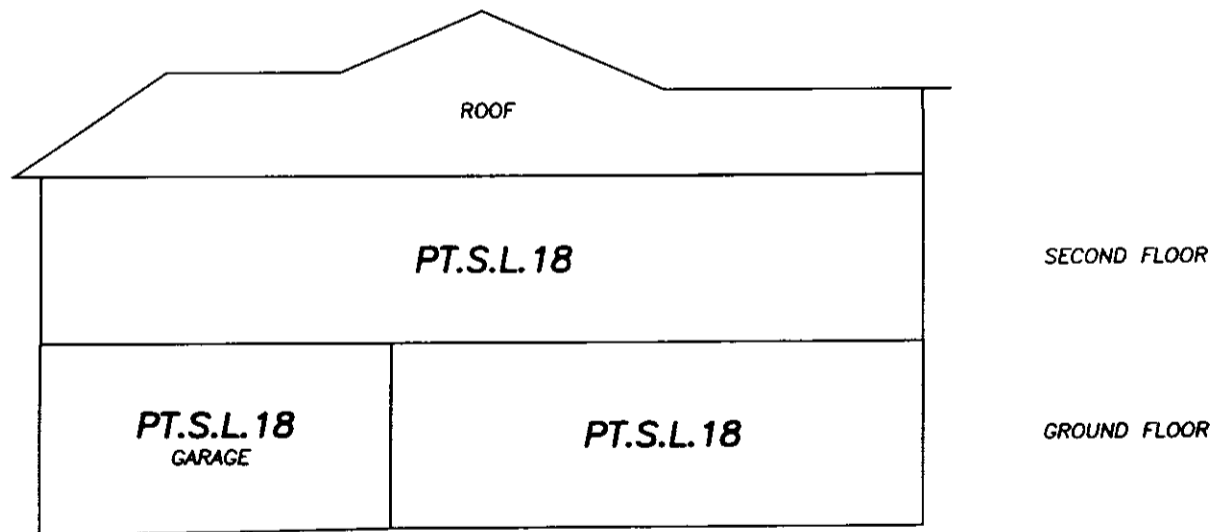

SECTION B13-B13

JOHNSON C. TAM, B.C.L.S.

August 18th, 2005.

BUILDING 14
STRATA LOTS 19 AND 20

STRATA PLAN BCS 1465

SCALE: 1:125

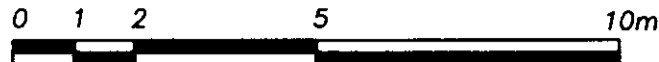
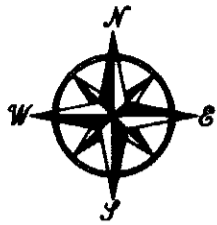

ALL DISTANCES ARE IN METRES AND DECIMALS THEREOF UNLESS OTHERWISE INDICATED

B14

GROUND FLOOR

A14

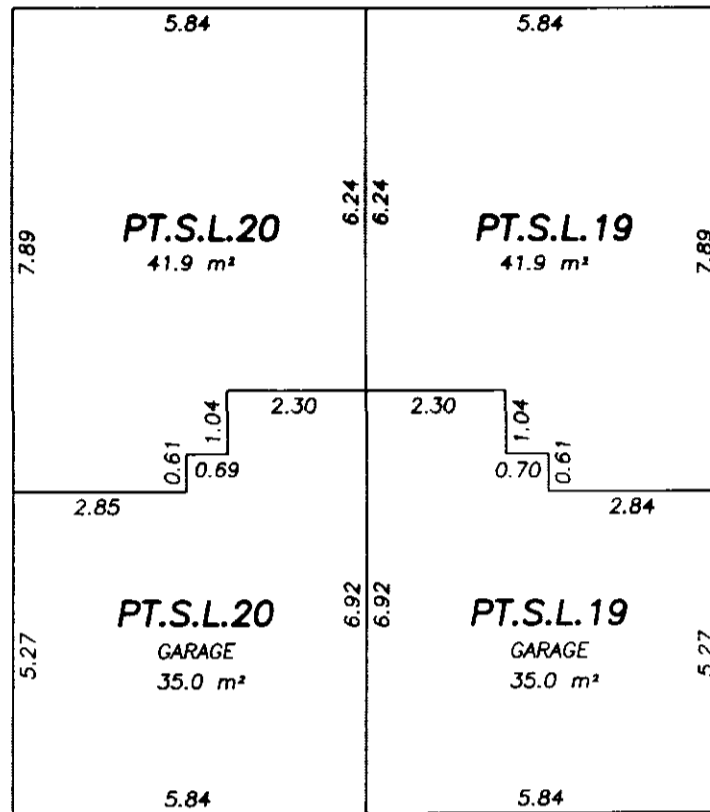

A14

B14

B14

SECOND FLOOR

A14

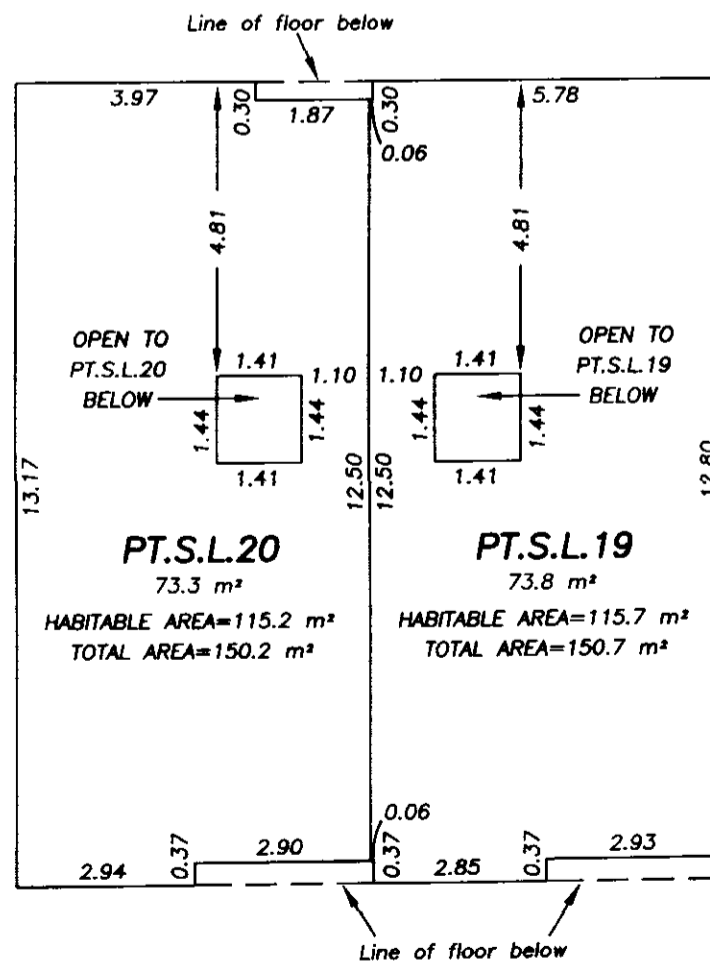

A14

B14

Johnson C. Tam
JOHNSON C. TAM, B.C.L.S.

August 18th, 2005.

BUILDING 14 SECTIONS

STRATA PLAN BCS 1465

SCALE: 1:125

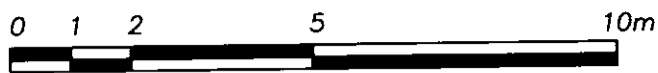

ALL DISTANCES ARE IN METRES AND DECIMALS THEREOF UNLESS OTHERWISE INDICATED

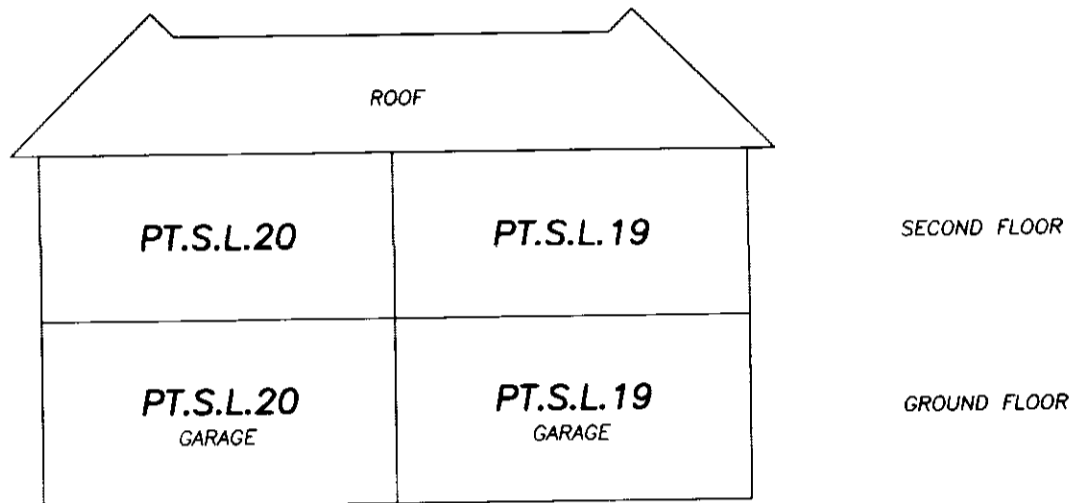

SECTION A14-A14

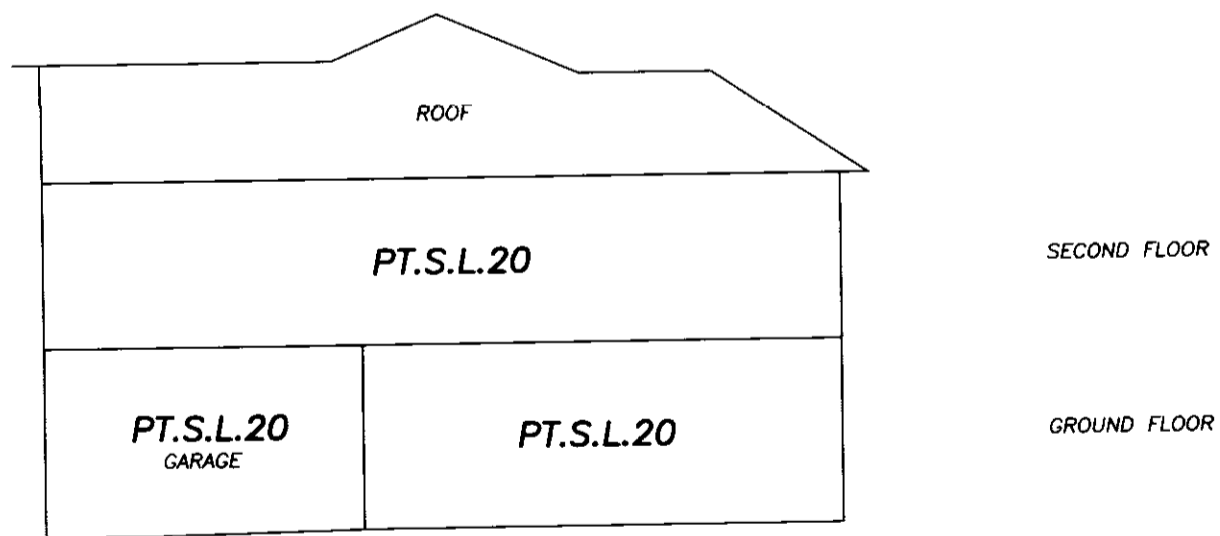

SECTION B14-B14



 JOHNSON C. TAM, B.C.L.S.

August 18th, 2005.

BUILDING 15
STRATA LOTS 21 AND 22

STRATA PLAN BCS 1465

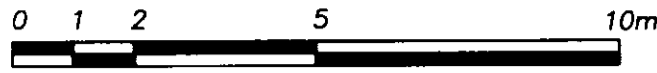
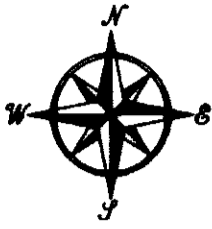
SCALE: 1:125



ALL DISTANCES ARE IN METRES AND DECIMALS THEREOF UNLESS OTHERWISE INDICATED

B15

GROUND FLOOR

A15

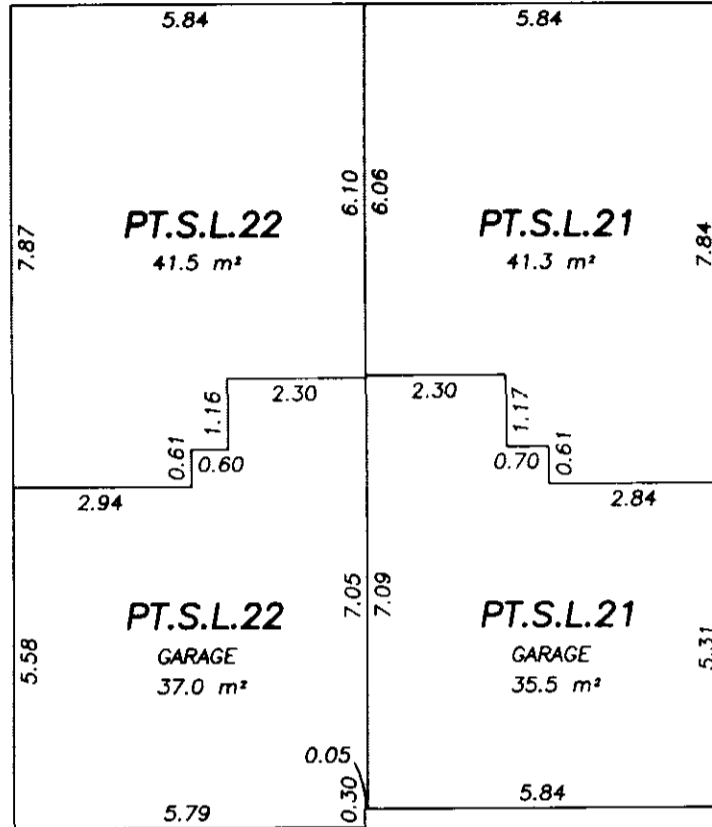

A15

B15

B15

SECOND FLOOR

A15

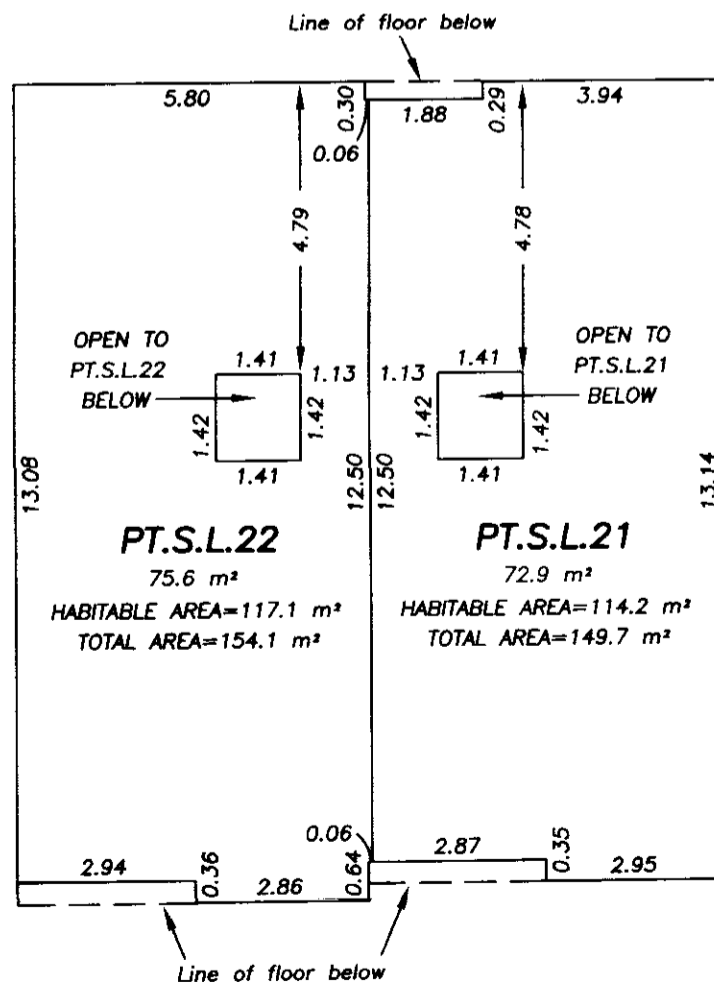

A15

B15

Johnson C. Tam
JOHNSON C. TAM, B.C.L.S.

August 18th, 2005.

BUILDING 15 SECTIONS

STRATA PLAN BCS 1465

SCALE: 1:125

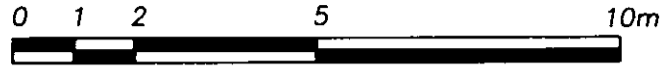

ALL DISTANCES ARE IN METRES AND DECIMALS THEREOF UNLESS OTHERWISE INDICATED

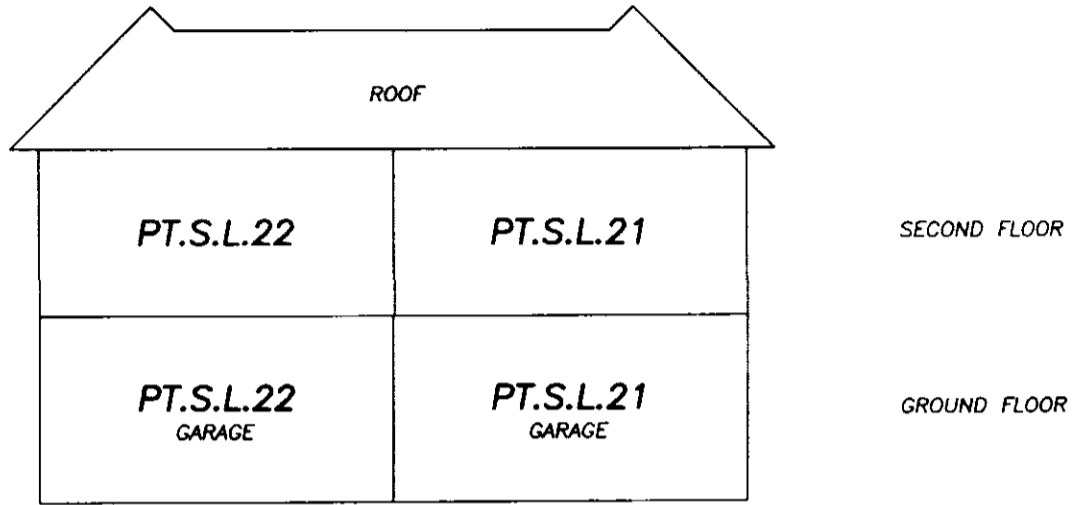

SECTION A15-A15

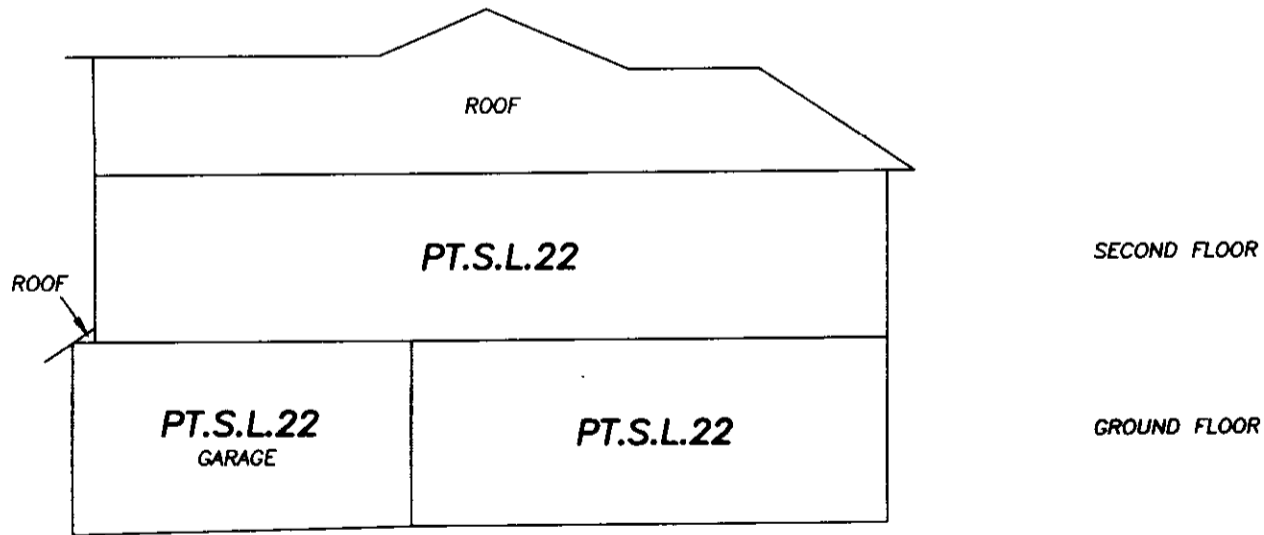

SECTION B15-B15

 JOHNSON C. TAM, B.C.L.S.

August 18th, 2005.

BUILDING 16
STRATA LOTS 23 AND 24

STRATA PLAN BCS 1465

SCALE: 1:125



ALL DISTANCES ARE IN METRES AND DECIMALS
THEREOF UNLESS OTHERWISE INDICATED



B16

GROUND FLOOR

A16

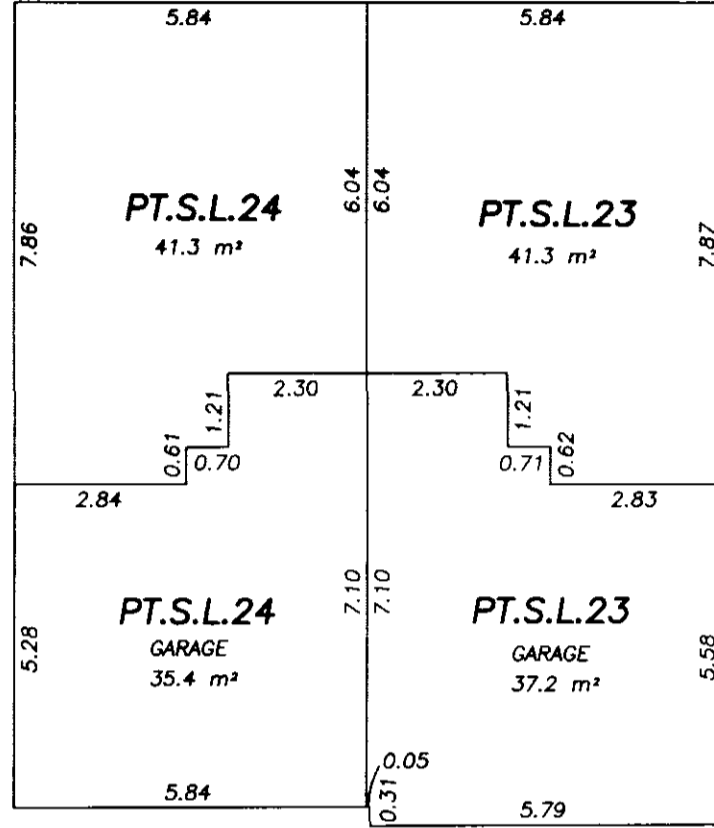

A16

B16

B16

SECOND FLOOR

A16

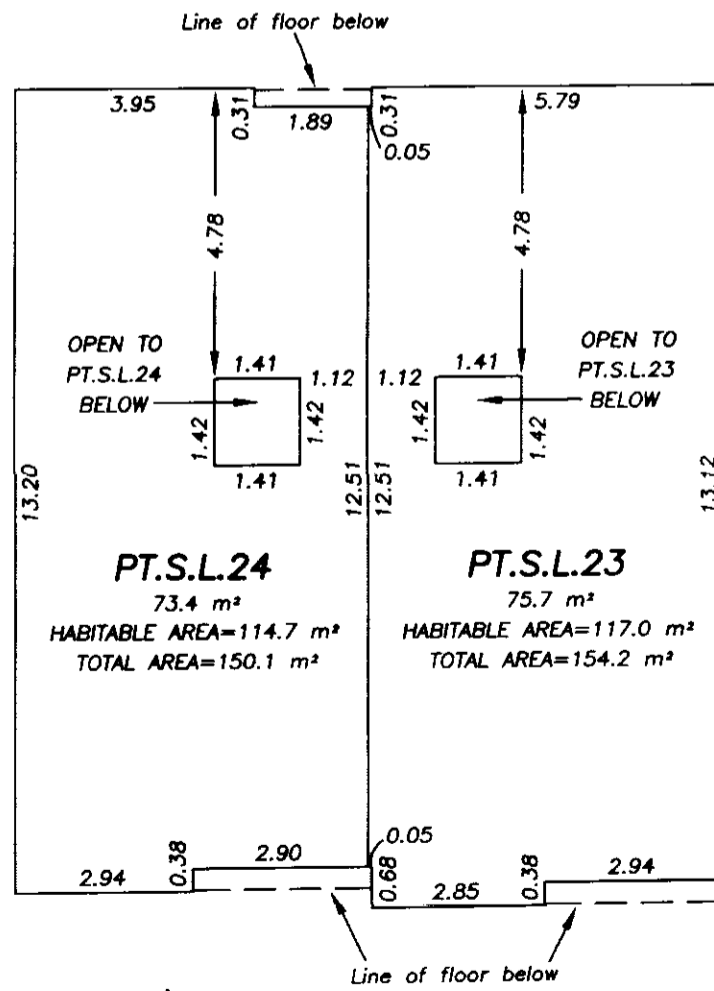

A16

B16

Johnson C. Tam
JOHNSON C. TAM, B.C.L.S.

August 18th, 2005.

BUILDING 16 SECTIONS

STRATA PLAN BCS 1465

SCALE: 1:125

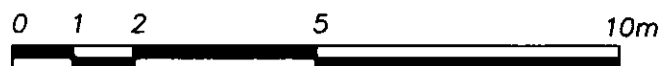

ALL DISTANCES ARE IN METRES AND DECIMALS THEREOF UNLESS OTHERWISE INDICATED

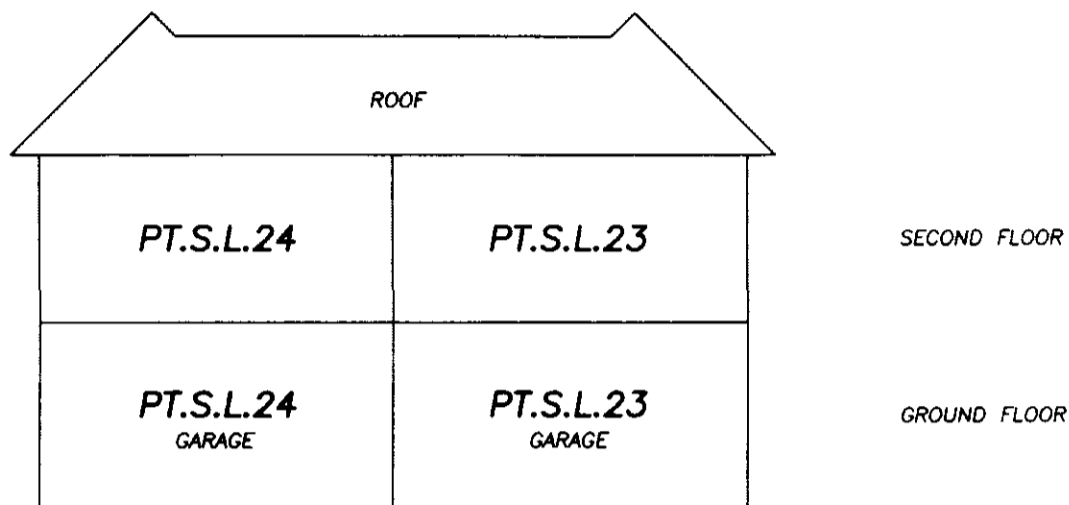

SECTION A16-A16

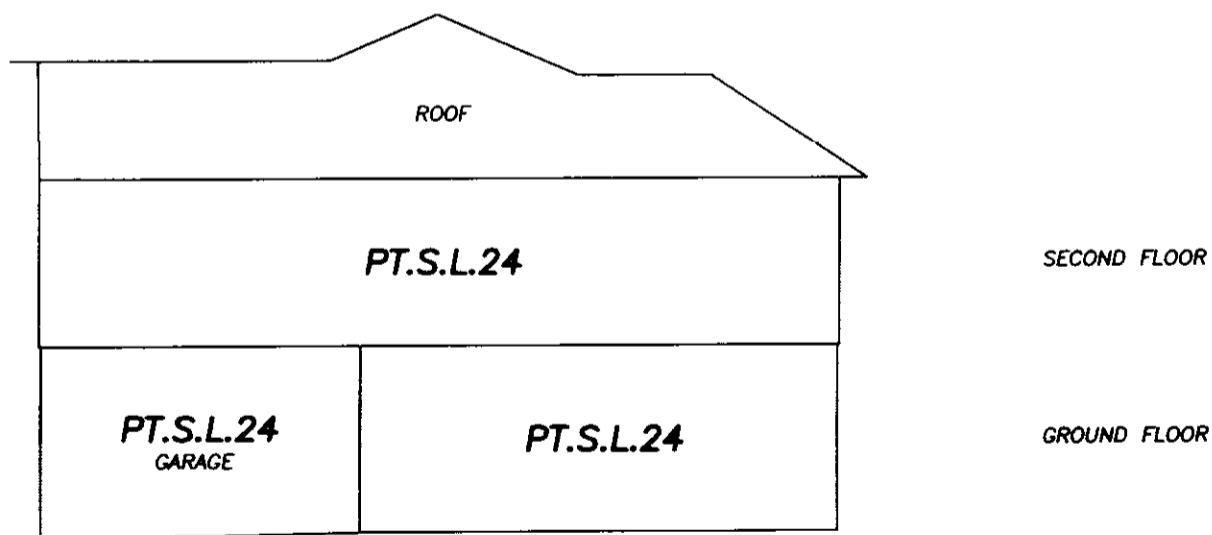

SECTION B16-B16

JOHNSON C. TAM, B.C.L.S.

August 18th, 2005.

BUILDING 7
STRATA LOT 25

STRATA PLAN BCS 1465

SCALE: 1:125

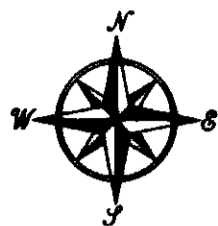

ALL DISTANCES ARE IN METRES AND DECIMALS
THEREOF UNLESS OTHERWISE INDICATED

GROUND FLOOR

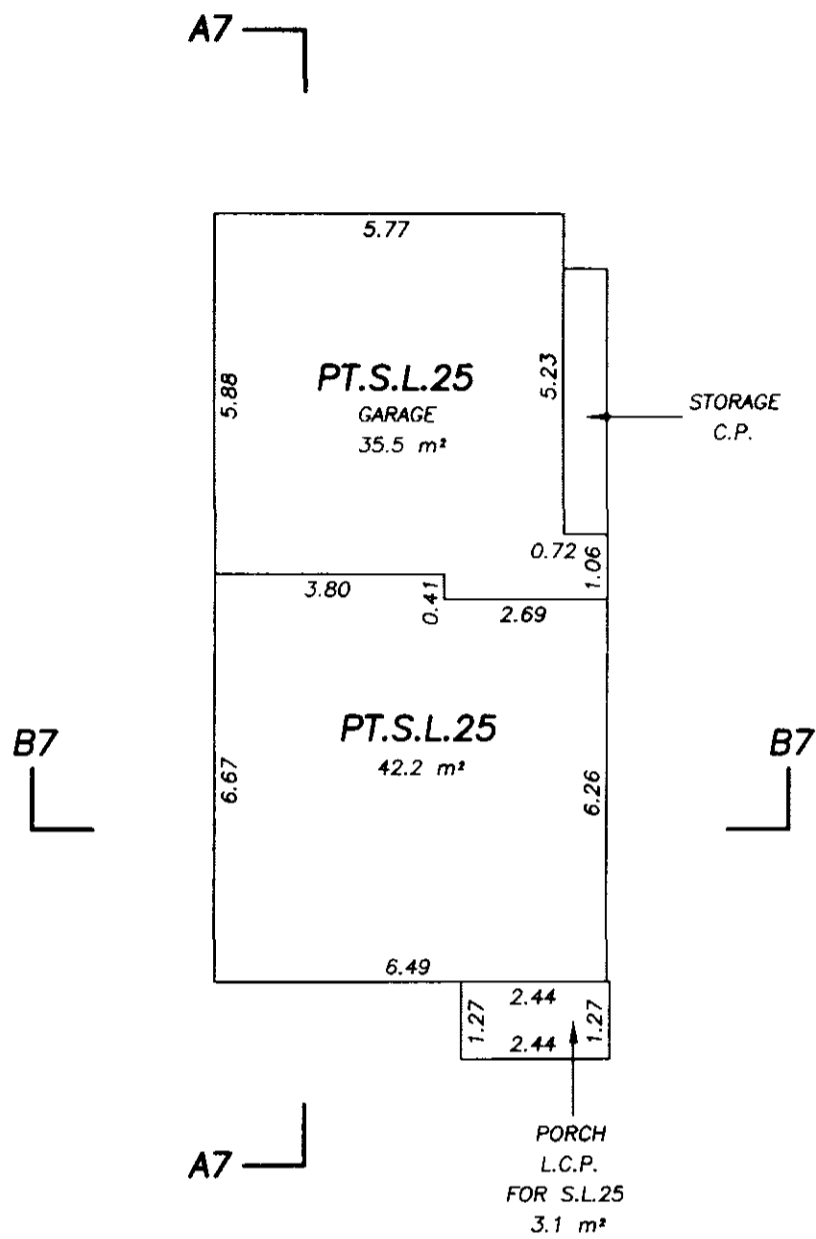

SECOND FLOOR

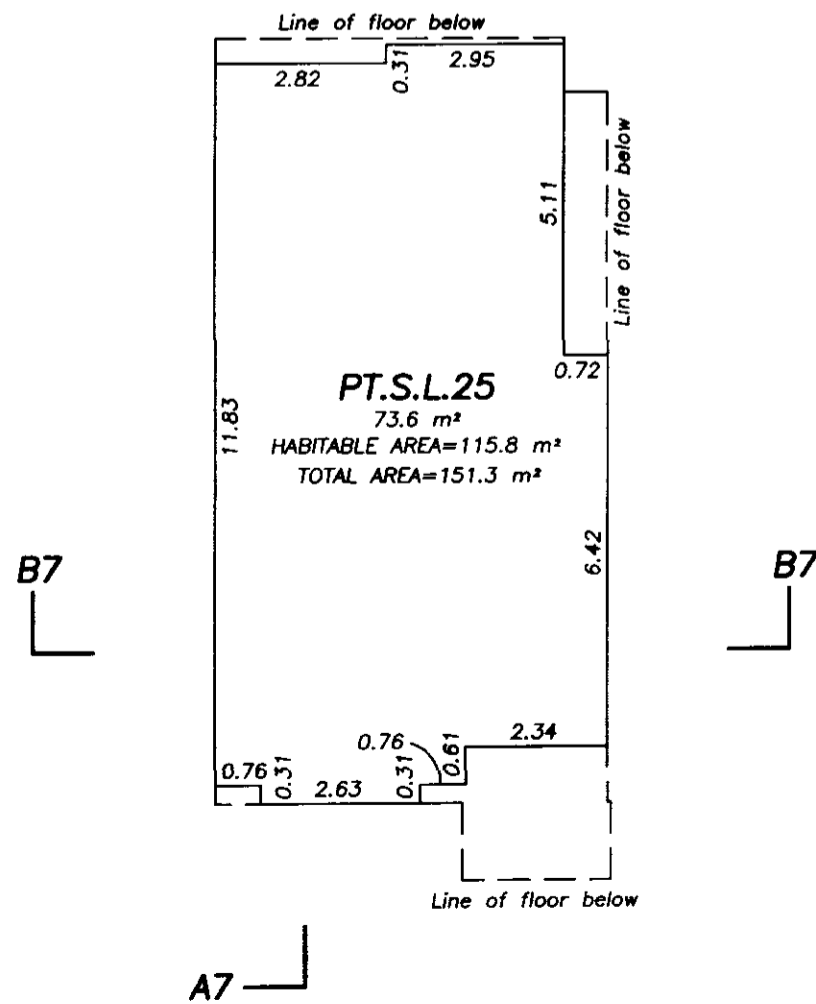

Johnson C. Tam
JOHNSON C. TAM, B.C.L.S.

August 18th, 2005.

BUILDING 7 SECTIONS

STRATA PLAN BCS 1465

SCALE: 1:125

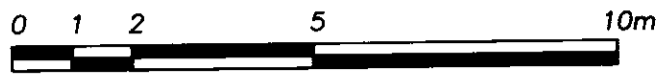

ALL DISTANCES ARE IN METRES AND DECIMALS THEREOF UNLESS OTHERWISE INDICATED

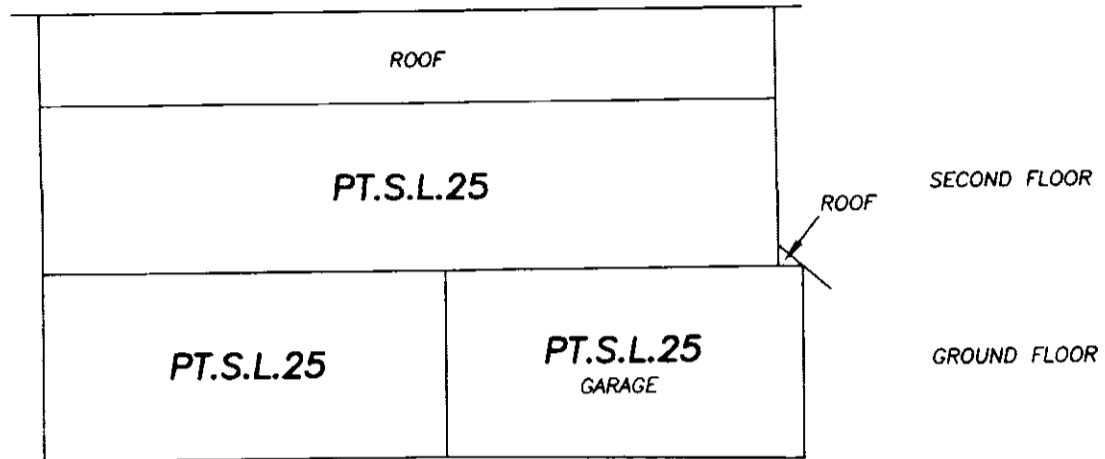

SECTION A7-A7

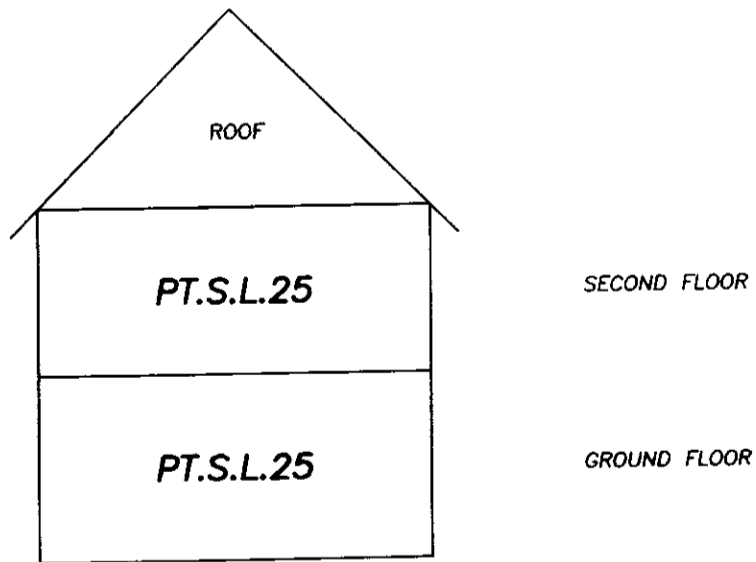

SECTION B7-B7

JOHNSON C. TAM, B.C.L.S.

August 18th, 2005.

BUILDING 6
STRATA LOTS 26 AND 27

STRATA PLAN BCS 1465

SCALE: 1:125

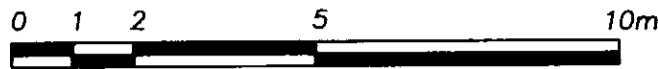

ALL DISTANCES ARE IN METRES AND DECIMALS
THEREOF UNLESS OTHERWISE INDICATED

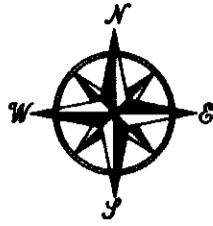

GROUND FLOOR

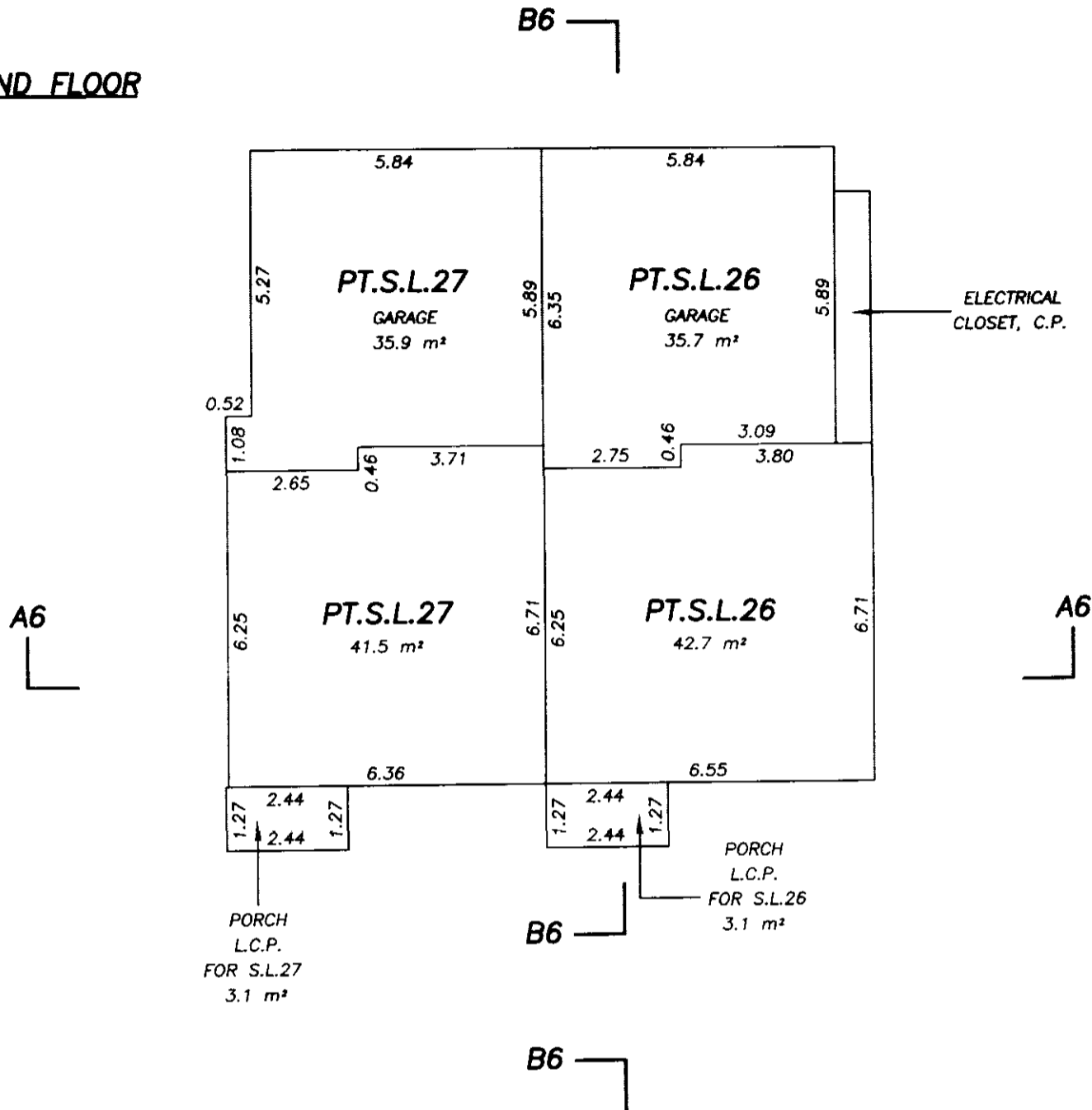

SECOND FLOOR

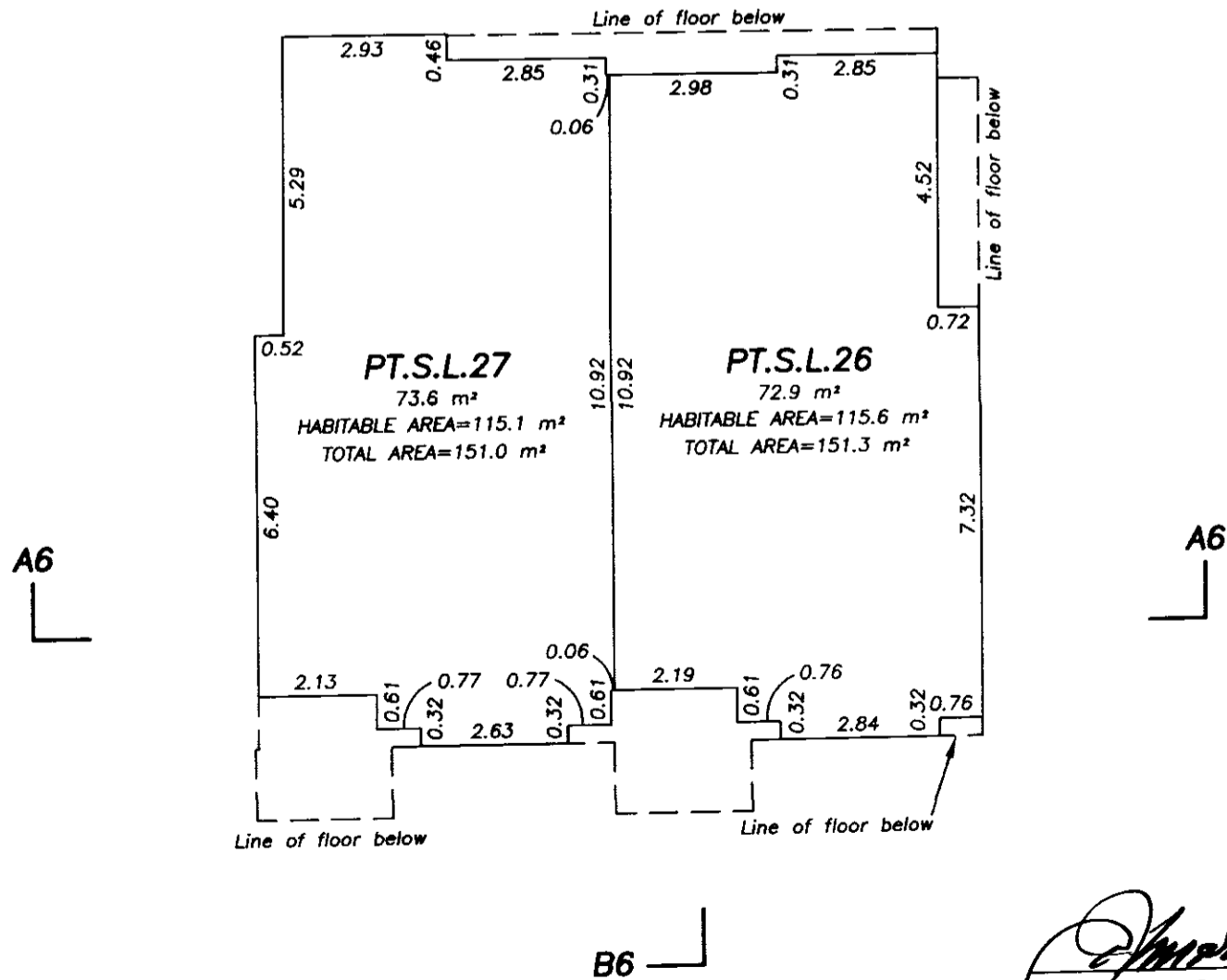

Johnson C. Tam
JOHNSON C. TAM, B.C.L.S.

August 18th, 2005.

FILED
NWBCS1465
S33058 2005-12-02-12.01.35.196315

BUILDING 6 SECTIONS

STRATA PLAN BCS 1465

SCALE: 1:125

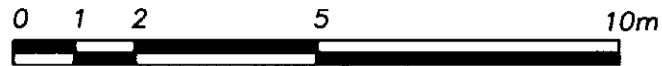

ALL DISTANCES ARE IN METRES AND DECIMALS
THEREOF UNLESS OTHERWISE INDICATED

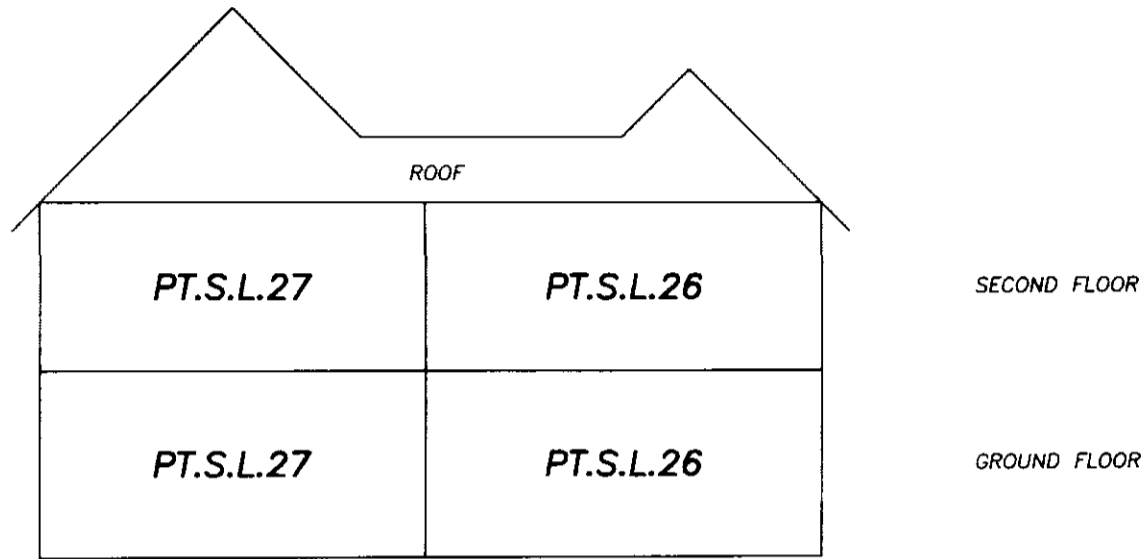

SECTION A6-A6

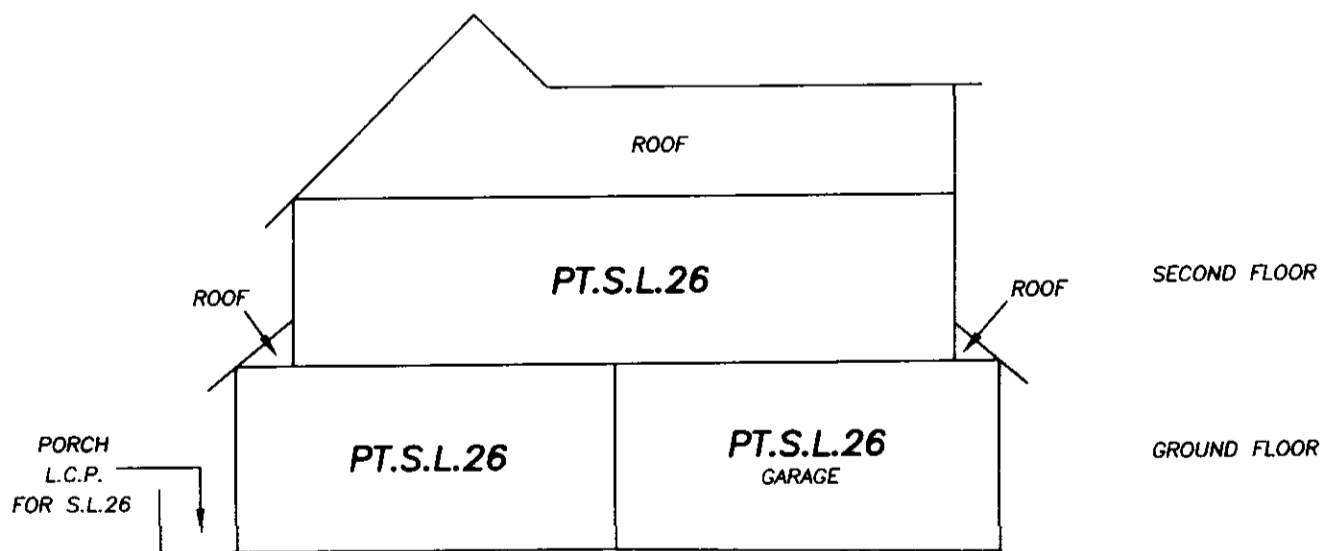

SECTION B6-B6

JOHNSON C. TAM, B.C.L.S.

August 18th, 2005.

FILED NWBCS1465 S33058 2005-12-02-12.01.35.196315

BUILDING 1
STRATA LOTS 28 AND 29

STRATA PLAN BCS 1465

SCALE: 1:125

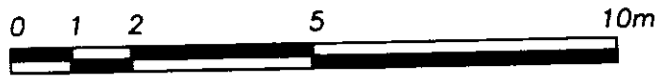

ALL DISTANCES ARE IN METRES AND DECIMALS
THEREOF UNLESS OTHERWISE INDICATED

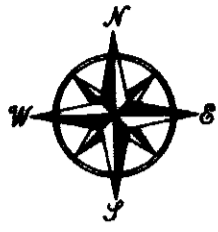

GROUND FLOOR

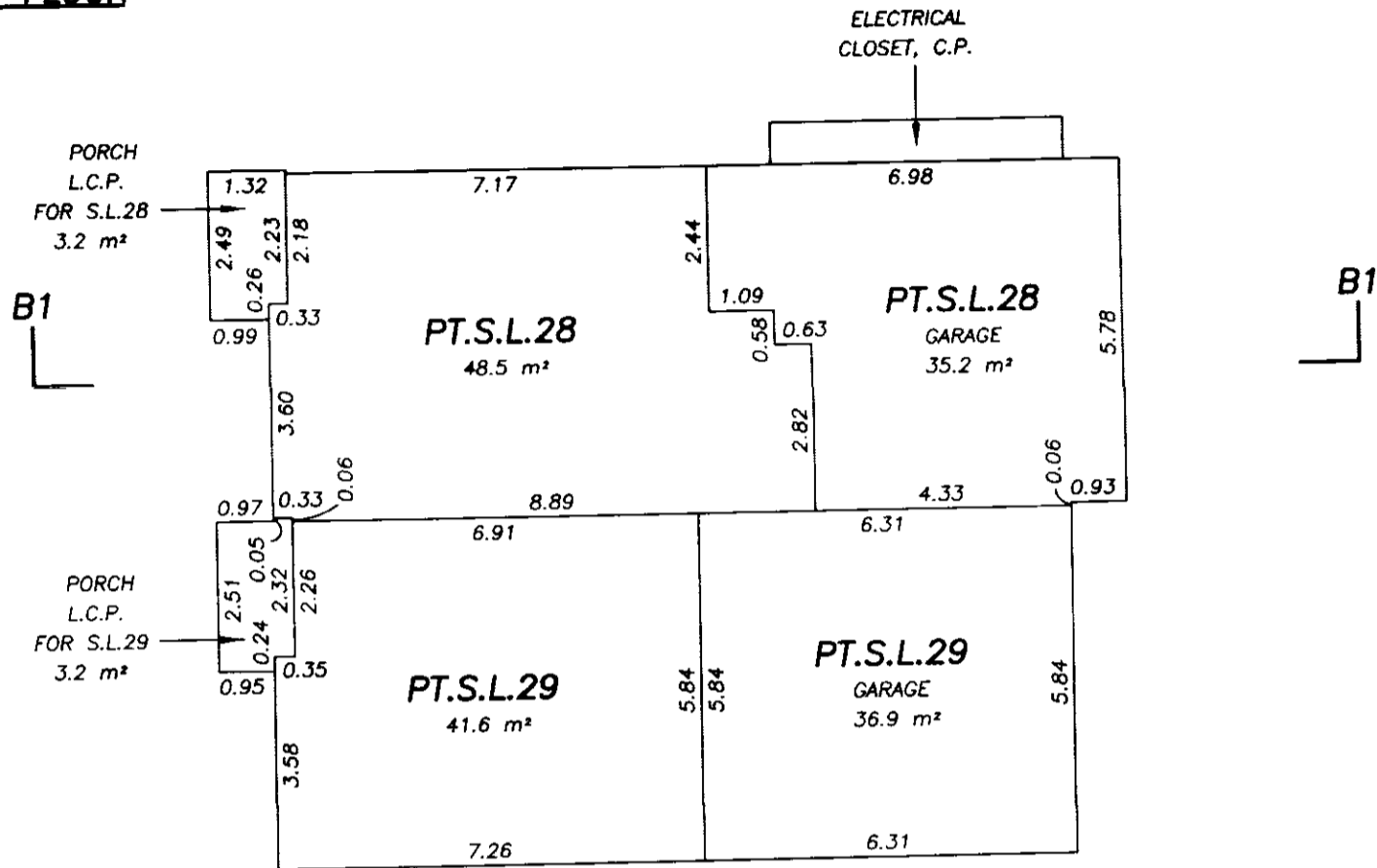

SECOND FLOOR

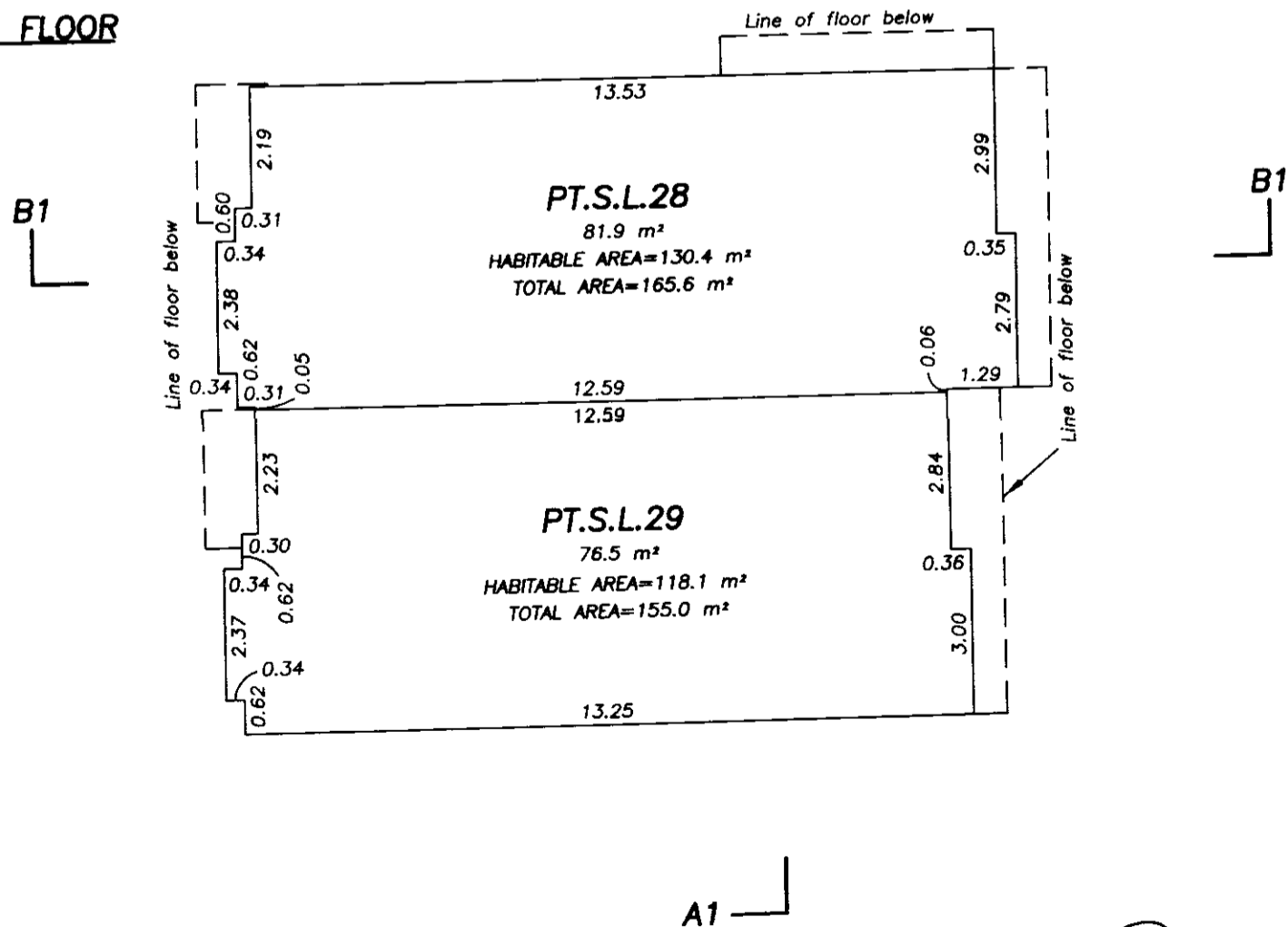

Johnson C. Tam
JOHNSON C. TAM, B.C.L.S.

August 18th, 2005.

BUILDING 1 SECTIONS

STRATA PLAN BCS 1465

SCALE: 1:125

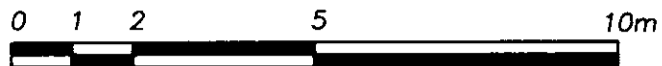

ALL DISTANCES ARE IN METRES AND DECIMALS THEREOF UNLESS OTHERWISE INDICATED

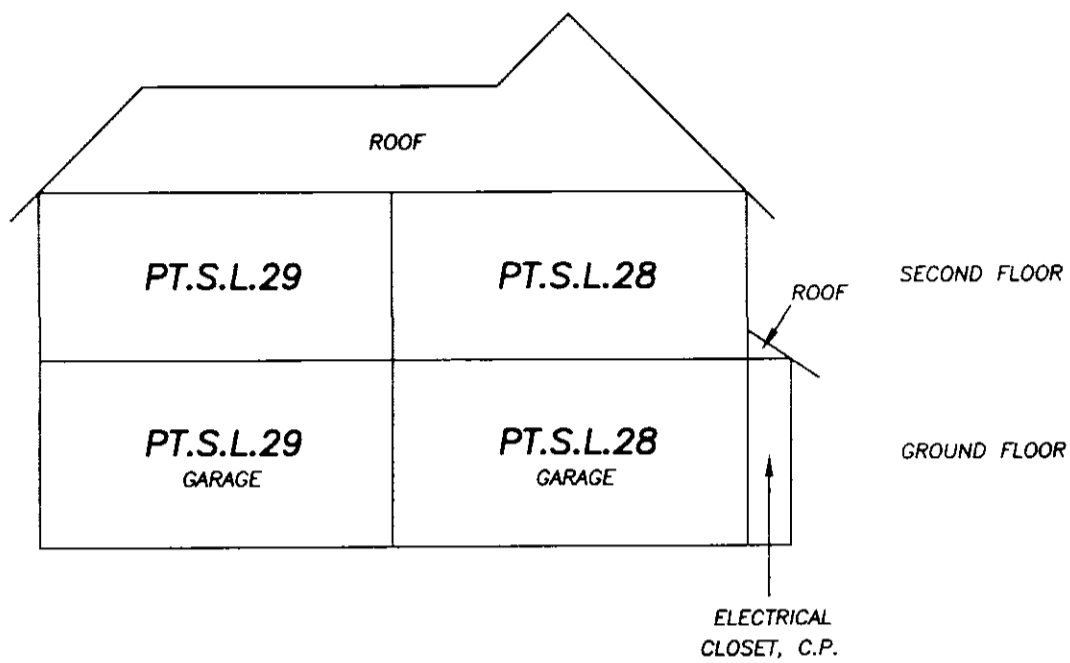

SECTION A1-A1

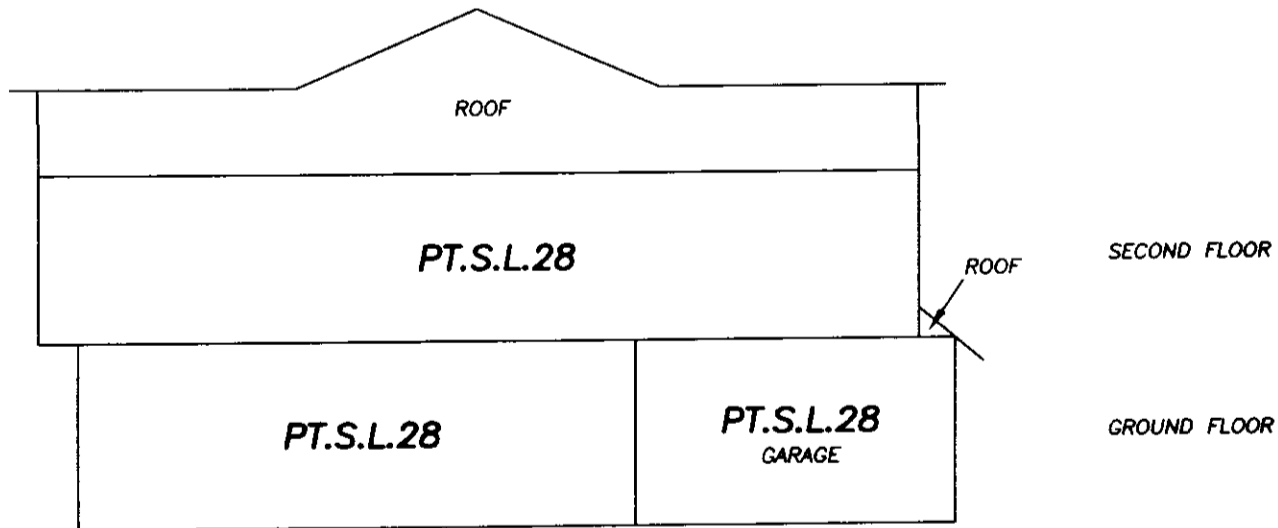

SECTION B1-B1

 JOHNSON C. TAM, B.C.L.S.

August 18th, 2005.